



la tavola[®]
COMPLETE CATALOGUE 2021

Table of contents

Company profile

About Us	06
----------------	----

Flatware



TENDENCE COLLECTION

Rainbow	18
Première	20
New Wave	22
Yuki	24
Chill-out	26
Urban	28
Fusion	30
Lounge	32
Charme	34
Curva	36

CLASSIC COLLECTION

Aida	38
Norma	40
Tosca	42
Lucia	44
Carmen	46

Serving items	48
Titanium finish	50
Rétro finish	52
Finishings and materials	54

Buffetware

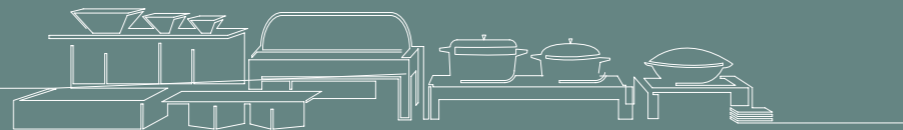

WARMING FUNCTIONS

Magic Chafer	66
Magic Chafer with stand	68
Oyster Chafer	72
Wonder Chafer	74

Classic Chafers	75
Warming Plate	76
Carving Station	78
Warming Tray	79
Dry Chafer	80
Mini Chafer	81
Induction Warming Top	82
Multi Point Induction Warming Plate	83

WARMING&COOLING FUNCTION

Hot&Cold Plate	84
----------------------	----

COOLING FUNCTIONS

Cooling Plate	86
Chill-it Cooling System	88
Cold Well	89
Cooling Tray	90
Oyster & Fruit de Mer Display	91
Pot and Butter Cooler	92
Cold Drinks	93

COOKING FUNCTIONS

Wok Station	94
Cooking Station	94
Grill Teppanyaki Station	94

MARKET DISPLAYS

Market Stands and Flower Pots	98
Flyover	99
The Tree Riser	99
Multi-level Displays	100
Market Boxes and Trays	102
Market Elevation System	104
Elevations and Crosses	106
Elevation Tops	107

ORGANIC & MINERAL RISERS

Cube Risers	118
Corner Risers	119
Cut Risers	120
High&Low Risers	121
Risers Tops	122

BUFFET ESSENTIALS

Display Trays	128
High&Low Porcelain Displays	130
Multipurpose and Presentation Trays	132
Wine Coolers	133
Jug-holders	134

- Juice and Milk Dispensers 134
- Hot Beverages and Cereals Dispensers 134
- Cloud Stand 136
- Revolving Multi-tiers Stand 136
- Footed Cake Plate 136
- Bread Cutting Board 137
- Polyethylene Cutting Board 137
- Sloping Display 137
- Lace Basket 137
- Checkers Basket 137
- Health Shield 138
- Sneeze Guard 139

Action Stations

PLATFORMS

- Elemento 144
- Nesting Table 148
- Magic Cart 152
- The Grand 156
- The Bridge 158
- Catering Table 160
- Magic Table 162

FUNCTIONAL MODULES

- Warm Holding Modules 166
- Warm&Cold Holding Modules 169
- Cold Holding Modules 170
- Professional Cooking Modules 172
- Beverage&Mixology Modules 174
- Accessories for functional modules 175

Icona®

- Icona® for Warm Holding 182
- Icona® for Cold Holding 184
- Icona® for Show Cooking 186
- Add-Ons for Icona® 188

Mobile Banqueting Furniture

BUFFET TABLES

- Lite Nesting Tables 194
- Foldable Buffet Tables 200
- Foldable Cocktail Tables 202



MIXOLOGY, BEVERAGE & VERTICAL DISPLAYS

- Front Bar & Mixology Front Bar 208
- Mixology Cart with Shock Freezer 210
- Mixology Cart 212
- Mixology Rover 214
- Beer Cart 216
- Wine Tasting Cart 217
- Foldable Back Bar 218
- Foldable Front Bar 219
- The Tower 221
- Back Bar 222
- The Octopus 223
- The Egg 224
- The Tree 225

DEDICATED CARTS AND TABLES

- Coffee Break Cart 228
- Convivium 230
- Conference Table 232
- Meeting Table 234
- Lectern 235
- Welcome Desk 235
- Room Divider 235
- Green Egg Cart 236
- Mini Fridge Cart 236
- Coffee Cabinet 237
- Ouzi Cart 237

HPL Finishes

- HPL Panels and Tops 238

Consulting

- Consulting 240
- Customization 244
- Luxury Items 250

Cocottes, Porcelain and Glassware

- Premium Quality Ceramics 254
- Premium Quality Ceramics Cocottes 256
- Cast Iron Cocottes 257
- Porcelain Items 258
- Decorative Glassware 260
- Patents and Proprietary Designs 262
- Warranties and Care and Maintenance 263

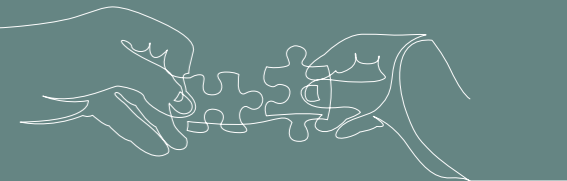

THE HOSPITALITY INDUSTRY A FAMILY AFFAIR

7 GENERATIONS
AT THE SERVICE OF
THE HOSPITALITY
INDUSTRY

LA TAVOLA IS A PERFECT REPRESENTATIVE OF THE NUMEROUS MEDIUM SIZED COMPANIES THAT FUEL ITALY'S ECONOMY: LA TAVOLA IS OWNED AND MANAGED BY THE SAMBONET FAMILY, WHOSE MEMBERS HAVE SUPPLIED AND SERVED THE HOSPITALITY INDUSTRY FOR GENERATIONS.

1831

THE BEGINNINGS. GIUSEPPE SAMBONET OPENS UP A WORKSHOP TO PRODUCE AND SELL SILVER HANDMADE CRAFTS.



1919

GIULIO SAMBONET GROWS THE SHOP INTO A FACTORY. THE FACTORY LOCATION IS IN VERCELLI, IN THE SAME BUILDING WHERE THE LA TAVOLA SHOWROOM FINDS ITS CURRENT LOCATION.

1946

GIORGIO LEADS THE COMPANY'S EXPANSION TO THE FOREIGN MARKET. LATER IN HIS LIFE HE WILL FOCUS ON HIS CAREER AS A PAINTER AND WRITER, HIS WORK IS CURRENTLY SHOWCASED IN 3 DIFFERENT MUSEUMS IN VERCELLI, ITALY.



1974

GIULIO AND SERGIO SAMBONET CONCENTRATE THEIR EFFORT IN SERVING THE HOSPITALITY INDUSTRY. THEY MANAGE THE SAMBONET COMPANY UNTIL 1986, YEAR IN WHICH THEY SELL THEIR SHARES TO START NEW COMPANIES: TABLE TOP ENGINEERING & DESIGN, SANT'ANDREA (IN PARTNERSHIP WITH ONEIDA) AND LA TAVOLA®.

2011

MATTEO JOINS THE TEAM, THE 7TH GENERATION OF THE SAMBONET FAMILY TO NURTURE A PASSION FOR THE HOSPITALITY INDUSTRY.



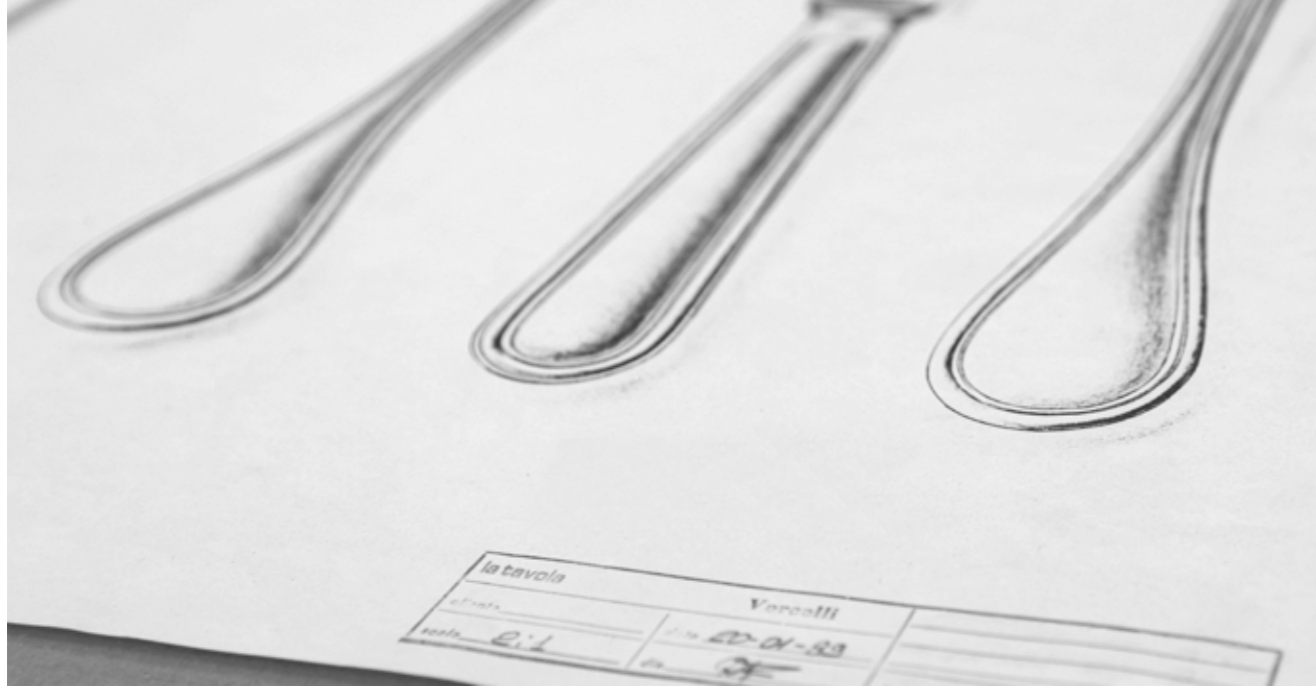

FACTORY AND SHOWROOM

VISIT OUR SHOWROOM LOCATED IN THE HISTORICAL CITY OF VERCELLI



THE SHOWROOM IS LOCATED IN THE HEART OF THE HISTORICAL PIEDMONTENE CITY OF VERCELLI, ITALY. THE SPACE HAS BEEN REPURPOSED FROM THE ORIGINAL (1920 - 1946) SAMBONET FAMILY SILVERSMITHING FACTORY TO A SHOWROOM. MORE THAN 500 M² OF EXPOSITION SPACE. YOU ARE VERY INVITED TO VISIT US!

SINCE LATE 2017, AND AFTER A BID TO EXPAND ITS OPERATIONS TO MEET GROWING DEMAND, LA TAVOLA OPERATES TWO BUILDINGS OF 2500 SQM AND 5000 SQM RESPECTIVELY FOR ITS PRODUCTION AND WAREHOUSING OPERATIONS.



WE PROUD OURSELVES WITH DESIGNING ALL OF OUR PRODUCTS IN-HOUSE AND WITH MAKING MOST OF THEM IN OUR FACTORY IN VERCELLI, ITALY.

ITALIAN DESIGN, TECHNOLOGY & MANUFACTURING



Flatware

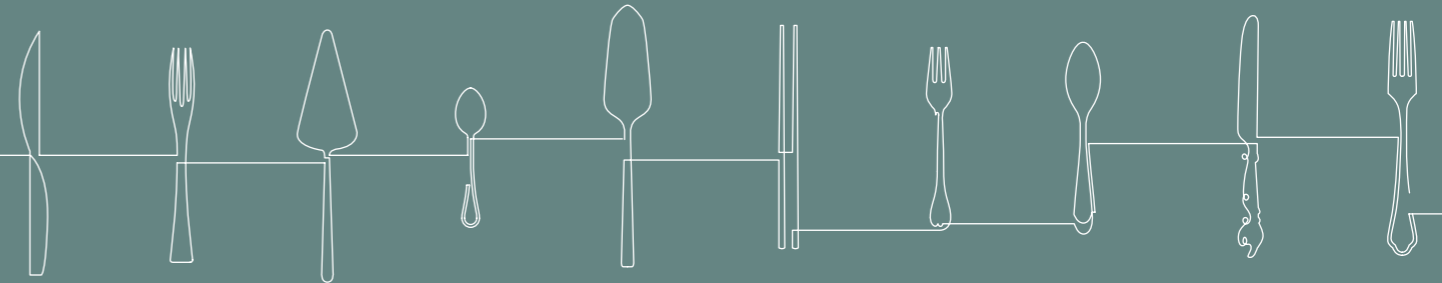

La Tavola reflects the passion of Giulio and Sergio Sambonet, brothers and founders who share an unending desire to create art for the table.

With the support of an experienced, expert and equally enthusiastic team, they are proud to present new flatware patterns in stainless steel, silver-plated and titanium and PVD coated finishes.

The patterns of this collection have been designed by La Tavola R&D Team under the supervision of Giulio and Sergio Sambonet.

Those personally designed by them are identified by the trademarks:



la tavola®

Tendance, Classic and Rétro collections





Urban



Lounge



Chill Out



Yuki



New Wave



Fusion



Curva



Charme



Shape of beauty
Rainbow cod. 16



LEN / THK (mm)	Item	LEN / THK (mm)	Item
216/5	001 - Table spoon	206/5	009 - Fish fork
216/5	002 - Table fork	238/5	010 - Fish knife
245	003 - Table knife solid handle	140/3	011 - Tea spoon
192/4	005 - Dessert spoon	117/2,5	012 - Demitasse spoon
192/4	006 - Dessert fork	180/3	013 - Ice tea spoon
225	007 - Dessert knife solid handle	180/4	014 - Soup spoon
206/5	009 - Fish fork	192/4	015 - Sauce spoon
238/5	010 - Fish knife	158/3	016 - Cake fork
140/3	011 - Tea spoon	150/3	017 - Oyster fork
117/2,5	012 - Demitasse spoon	200	018 - Butter knife solid handle
180/3	013 - Ice tea spoon	245	021 - Steak knife solid handle
180/4	014 - Soup spoon	244/5	023 - Serving spoon
192/4	015 - Sauce spoon	244/5	024 - Serving fork
158/3	016 - Cake fork	260/5	025 - Cake server
150/3	017 - Oyster fork	278/5	026 - Ladle
200	018 - Butter knife solid handle	184/5	027 - Sauce ladle
245	021 - Steak knife solid handle		
244/5	023 - Serving spoon		
244/5	024 - Serving fork		
260/5	025 - Cake server		
278/5	026 - Ladle		
184/5	027 - Sauce ladle		

Steak knife



Available versions

- 18/10 Stainless steel (TT mirror or TS satin finish)
- Silverplated (VT mirror or VS satin finish)
- Black titanium (TN mirror finish)
- Venetian gold (TR mirror finish)
- Gold (TO mirror finish)
- Platinum champagne (TC mirror finish)

HOW TO COMPOSE THE CODE
 FINISHING CODE + PATTERN CODE + ITEM CODE



The pattern!

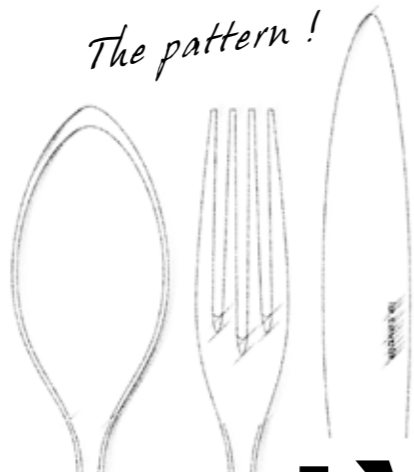

Première

cod. 15

LEN / THK (mm)	Item	LEN / THK (mm)	Item
217/4,5	001 - Table spoon	217/4,5	002 - Table fork
250	003 - Table knife solid handle	250	004 - Table knife hollow handle
193/4	005 - Dessert spoon	193/4	006 - Dessert fork
225	007 - Dessert knife solid handle	225	008 - Dessert knife hollow handle
205/4,5	009 - Fish fork	228/4,5	010 - Fish knife
143/3	011 - Tea spoon	117/2,5	012 - Demitasse spoon
180/3	013 - Iced tea spoon	182/4	014 - Soup spoon
190/4	015 - Sauce spoon	153/3	016 - Cake fork
145/3	017 - Oyster fork	190	018 - Butter knife solid handle
178/3	020 - Butter spreader	250/8,5	022 - Steak knife hollow handle
245/4,5	023 - Serving spoon	245/4,5	024 - Serving fork
255/4,5	025 - Cake server	278/4,5	026 - Ladle
174/4,5	027 - Sauce ladle	250/4,5	029 - Rice spoon

Steak knife, hollow handle



Available versions

- 18/10 Stainless steel (TT mirror, TB brush or TTR rétro finish)
- Silverplated (TS mirror finish)
- Black titanium (TN mirror finish)
- Venetian gold (TR mirror or TTR rétro finish)
- Gold (TO mirror or TTR rétro finish)
- Platinum champagne (TC mirror or TTRC rétro finish)





















HOW TO COMPOSE THE CODE
FINISHING CODE + PATTERN CODE + ITEM CODE



Contemporary music

New Wave

cod. 13

LEN / THK (mm)																				
	001 - Table spoon 218/4	002 - Table fork 215/4	003 - Table knife solid handle 253	005 - Dessert spoon 194/3,5	006 - Dessert fork 192/3,5	007 - Dessert knife solid handle 228	009 - Fish fork 215/4	010 - Fish knife 235/4	011 - Tea spoon 144/2,8	012 - Demitasse spoon 118/2,2	013 - Teal tea spoon 180/3	014 - Soup spoon 178/3,5	015 - Sauce spoon 190/3,5	016 - Cake fork 152/3	020 - Butter spreader 178/3	021 - Steak knife solid handle 250	023 - Serving spoon 246/4,5	024 - Serving fork 243/4,5	025 - Cake server 255/4	026 - Ladle 278/5













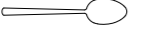
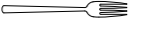









Available versions
 18/10 Stainless steel (TT mirror or TS satin finish)
 Silverplated (VT mirror or VS satin finish)
 Black titanium (TN mirror finish)
 Venetian gold (TR mirror finish)
 Gold (TO mirror finish)
 Platinum champagne (TC mirror finish)

HOW TO COMPOSE THE CODE
 FINISHING CODE + PATTERN CODE + ITEM CODE



LEN / THK (mm)

- 001 - Table spoon 207/4,5 
- 002 - Table fork 207/4,5 
- 003 - Table knife solid handle 235 
- 005 - Dessert spoon 190/4 
- 006 - Dessert fork 190/4 
- 007 - Dessert knife solid handle 216 
- 009 - Fish fork 207/4,5 
- 010 - Fish knife 228/4,5 
- 011 - Tea spoon 143/3 
- 012 - Demitasse spoon 114/2,5 
- 013 - Iced tea spoon 180/3 
- 014 - Soup spoon 181/4 
- 015 - Sauce spoon 190/4 
- 016 - Cake fork 151/3 
- 018 - Butter knife solid handle 186 
- 021 - Steak knife solid handle 235 
- 023 - Serving spoon 234/4,5 
- 024 - Serving fork 234/4,5 
- 025 - Cake server 251/4,5 
- 026 - Ladle 278/5 
- 030 - Chopsticks - 2 pieces, st. st. satin finish 230/4,8 
- 031 - Chopsticks holder, st. st. mirror finish 50/10 

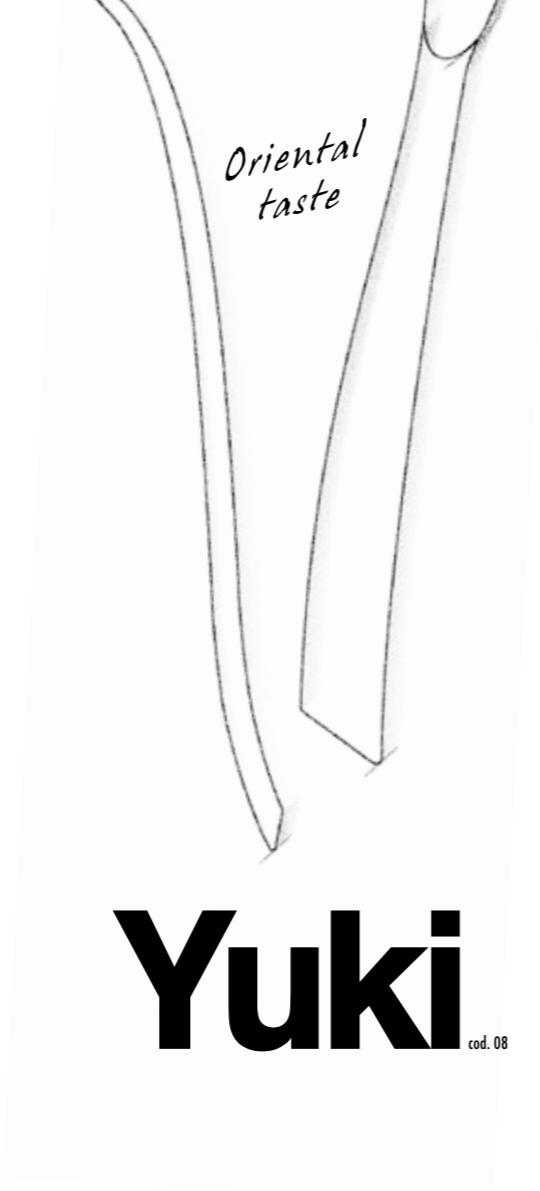

Yuki cod. 08



- Available versions**
- 18/10 Stainless steel (TT mirror or TS satin finish)
 - Silverplated (VT mirror or VS satin finish)
 - Black titanium (TN mirror finish)
 - Venetian gold (TR mirror finish)
 - Gold (TO mirror finish)
 - Platinum champagne (TC mirror finish)













HOW TO COMPOSE THE CODE
FINISHING CODE + PATTERN CODE + ITEM CODE

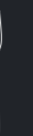
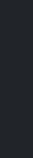
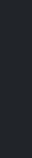
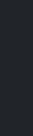

Vision de rêve

Chill Out cod. 11

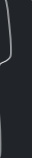
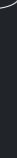
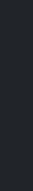

LEN / THK (mm)	Item
001 - Table spoon 210/5	
002 - Table fork 210/5	
003 - Table knife solid handle 240	
004 - Table knife hollow handle 240	
005 - Dessert spoon 191/3,5	
006 - Dessert fork 191/3,5	
007 - Dessert knife solid handle 225	
008 - Dessert knife hollow handle 225	
009 - Fish fork 210/4	
010 - Fish knife 226/4	
011 - Tea spoon 144/3	
012 - Demitasse spoon 115/2,5	
014 - Soup spoon 183/3,5	
016 - Cake fork 153/3	
018 - Butter knife solid handle 190	
021 - Steak knife solid handle 240	
023 - Serving spoon 237/5	
024 - Serving fork 237/5	
025 - Cake server 258/4	
026 - Ladle 278/5	



Available versions
 18/10 Stainless steel (TT mirror or TS satin finish)
 Silverplated (VT mirror or VS satin finish)

HOW TO COMPOSE THE CODE
 FINISHING CODE + PATTERN CODE + ITEM CODE



LEN / THK (mm)	
206/4,5	001 - Table spoon
206/4,5	002 - Table fork
240	003 - Table knife solid handle
240	004 - Table knife hollow handle
190/4	005 - Dessert spoon
190/4	006 - Dessert fork
221	007 - Dessert knife solid handle
221	008 - Dessert knife hollow handle
207/4,5	009 - Fish fork
228/4,5	010 - Fish knife
144/3	011 - Tea spoon
113/2,5	012 - Demitasse spoon
186/4	014 - Soup spoon
196/4	015 - Sauté spoon
151/3	016 - Cake fork
192	018 - Butter knife solid handle
233/4,5	023 - Serving spoon
233/4,5	024 - Serving fork
258/4,5	025 - Cake server
270/4,5	026 - Ladle

Urban cod. 18

Reflejos natural



Available versions

- 18/10 Stainless steel (TT mirror, TS satin or TTR rétro finish)
- Silverplated (VT mirror or VS satin finish)
- Venetian gold (TTRR rétro finish)
- Gold (TTRO rétro finish)
- Platinum champagne (TTRC rétro finish)

HOW TO COMPOSE THE CODE
FINISHING CODE + PATTERN CODE + ITEM CODE



LEN / THK (mm)	
001 - Table spoon	208/4,5
002 - Table fork	208/4,5
003 - Table knife solid handle	240
005 - Dessert spoon	190/4
006 - Dessert fork	190/4
007 - Dessert knife solid handle	220
009 - Fish fork	190/4
010 - Fish knife	206/4
011 - Tea spoon	147/3
012 - Demitasse spoon	113/2,8
014 - Soup spoon	184/4
015 - Sauce spoon	194/4
016 - Cake fork	160/3,2
018 - Butter knife solid handle	186
021 - Steak knife solid handle	225
023 - Serving spoon	246/4,5
024 - Serving fork	244/4,5
025 - Cake server	250/4
026 - Ladle	316/4,5

...harmony of Cultures

Fusion cod. 04



Available versions

18/10 Stainless steel (TT mirror or TS satin finish)
Silverplated (VT mirror or VS satin finish)

HOW TO COMPOSE THE CODE
FINISHING CODE + PATTERN CODE + ITEM CODE



Sounds of modern living



Lounge cod. 12

LEN / THK (mm)	ITEM CODE	DESCRIPTION
207/4,5	001	Table spoon
207/4,5	002	Table fork
246	003	Table knife solid handle
246	004	Table knife hollow handle
190/4	005	Dessert spoon
190/4	006	Dessert fork
225	007	Dessert knife solid handle
225	008	Dessert knife hollow handle
208/4	009	Fish fork
222/4	010	Fish knife
143/3	011	Tea spoon
114/2,5	012	Demitasse spoon
180/3	013	Tea spoon
179/4	014	Soup spoon
190/4	015	Sauce spoon
153/3	016	Cake fork
142/3	017	Oyster fork
196	018	Butter knife solid handle
222	021	Steak knife solid handle
236/4,5	023	Serving spoon
236/4,5	024	Serving fork
248/4,5	025	Cake server
278/4,5	026	Ladle



Available versions
 18/10 Stainless steel (TT mirror, TS satin, TB brush or TTR r tro finish)
 Silverplated (VT mirror or VS satin finish)
 Black titanium (TN mirror finish)
 Venetian gold (TR mirror or TTRR r tro finish)
 Gold (TO mirror or TTRO r tro finish)
 Platinum champagne (TC mirror or TTRC r tro finish)

HOW TO COMPOSE THE CODE
 FINISHING CODE + PATTERN CODE + ITEM CODE





Vivid elegance

Charme

cod. 21

LEN / THK (mm)	Item
205/4	001 - Table spoon
205/4	002 - Table fork
235	003 - Table knife solid handle
178/3	005 - Dessert spoon
178/3	006 - Dessert fork
205	007 - Dessert knife solid handle
205/3,5	009 - Fish fork
216/3,5	010 - Fish knife
143/2,5	011 - Tea spoon
114/2	012 - Demitasse spoon
180/2,5	013 - Iced tea spoon
170/3	014 - Soup spoon
150/2,5	016 - Cafe fork
180	018 - Butter knife solid handle
235	021 - Steak knife solid handle
236/4	023 - Serving spoon
236/4	024 - Serving fork



Available versions

- 18/10 Stainless steel (TT mirror, TS satin, TB brush or TTR rétro finish)
- Silverplated (VT mirror or VS satin finish)
- Black titanium (TN mirror finish)
- Venetian gold (TR mirror or TTR rétro finish)
- Gold (TO mirror or TTR rétro finish)
- Platinum champagne (TC mirror or TTRC rétro finish)

HOW TO COMPOSE THE CODE
FINISHING CODE + PATTERN CODE + ITEM CODE



LEN / THK (mm)	Item
210/4,5	001 - Table spoon
208/4,5	002 - Table fork
226	003 - Table knife solid handle
183/4	005 - Dessert spoon
181/4	006 - Dessert fork
197	007 - Dessert knife solid handle
208/4,5	009 - Fish fork
223/4,5	010 - Fish knife
144/3	011 - Tea spoon
115/2,5	012 - Demitasse spoon
180/3	013 - Iced tea spoon
174/4	014 - Soup spoon
151/3	016 - Cake fork
179	018 - Butter knife solid handle
238	021 - Steak knife solid handle
237/4,5	023 - Serving spoon
235/4,5	024 - Serving fork

Maverick Allure

Curva cod. 20



- Available versions**
- 18/10 Stainless steel (TT mirror, TS satin or TB brush)
 - Silverplated (VT mirror or VS satin finish)
 - Black titanium (TN mirror finish)
 - Venetian gold (TR mirror finish)
 - Gold (TO mirror finish)
 - Platinum champagne (TC mirror finish)





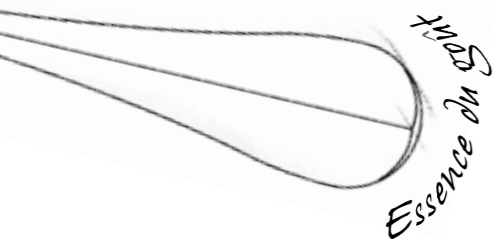







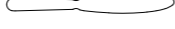
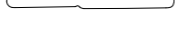





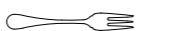

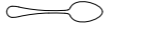
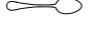

HOW TO COMPOSE THE CODE
FINISHING CODE + PATTERN CODE + ITEM CODE





Aida cod. 19

LEN / THK (mm)

001 - Table spoon	207/5	
002 - Table fork	207/5	
003 - Table knife solid handle	250	
003SB - Table knife solid handle	250	
004 - Table knife hollow handle	250	
005 - Dessert spoon	189/4,5	
006 - Dessert fork	189/4,5	
007 - Dessert knife solid handle	229	
007SB - Dessert knife hollow handle	229	
008 - Dessert knife hollow handle	229	
009 - Fish fork	189/4	
010 - Fish knife	206/4	
011 - Tea spoon	143/3,5	
012 - Demitasse spoon	112/2,5	
013 - Iced tea spoon	180/3,5	
014 - Soup spoon	175/4	
015 - Sauce spoon	189/4	
016 - Cake fork	150/3,5	
017 - Oyster fork	139/3,5	
021 - Steak knife solid handle	223	
023 - Serving spoon	234/5	
024 - Serving fork	234/5	
025 - Cake server	253/5	
026 - Ladle	277/5	
027 - Sauce ladle	173/4	



Available versions

- 18/10 Stainless steel (TT mirror, TB brush or TTR rétro finish)
- Silverplated (VT mirror finish)
- Black titanium (TN mirror finish)
- Venetian gold (TR rétro finish)
- Gold (TO mirror or TTRO rétro finish)
- Platinum champagne (TC mirror or TTRC rétro finish)

HOW TO COMPOSE THE CODE
FINISHING CODE + PATTERN CODE + ITEM CODE



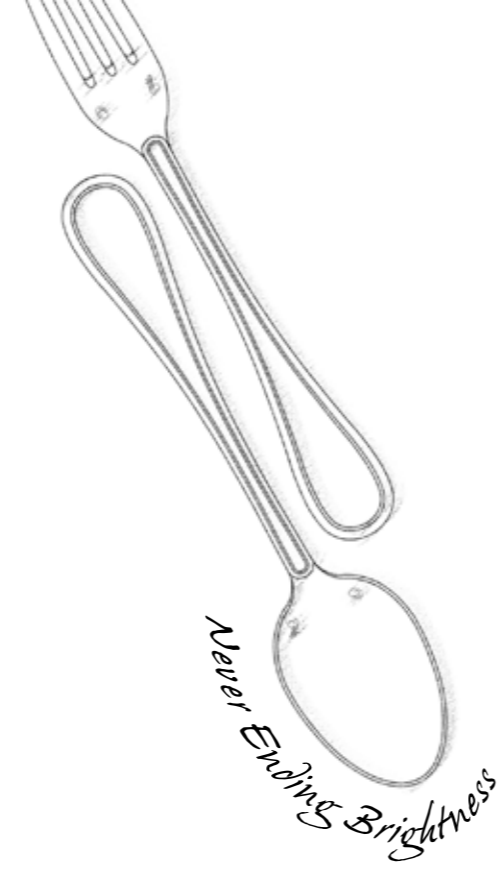

Norma cod. 01

LEN / THK (mm)	Item
204/3,5	001 - Table spoon
204/3,5	002 - Table fork
245	003 - Table knife solid handle
245	004 - Table knife hollow handle
187/3	005 - Dessert spoon
187/3	006 - Dessert fork
225	007 - Dessert knife solid handle
225	008 - Dessert knife hollow handle
187/3	009 - Fish fork
204/3	010 - Fish knife
143/2,8	011 - Tea spoon
107/2,5	012 - Demitasse spoon
180/2,5	013 - Iced tea spoon
178/3	014 - Soup spoon
190/3	015 - Source spoon
149/2,8	016 - Cake fork
140/2,5	017 - Oyster fork
184	018 - Butter knife solid handle
220	021 - Steak knife solid handle
223/3,5	023 - Serving spoon
223/3,5	024 - Serving fork
251/3,5	025 - Cake server
277/3,5	026 - Ladle



Available versions

- 18/10 Stainless steel (TT mirror finish)
- Silverplated (VT mirror finish)
- Black titanium (TN mirror finish)
- Venetian gold (TR mirror finish)
- Gold (TO mirror finish)

HOW TO COMPOSE THE CODE
FINISHING CODE + PATTERN CODE + ITEM CODE



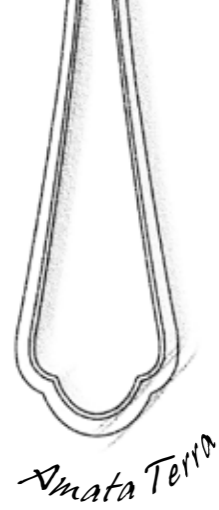

Tosca cod. 02

LEN / THK (mm)	Item Description
209/3,5	001 - Table spoon
209/3,5	002 - Table fork
255	003 - Table knife solid handle
255	004 - Table knife hollow handle
191/3	005 - Dessert spoon
191/3	006 - Dessert fork
230	007 - Dessert knife solid handle
230	008 - Dessert knife hollow handle
191/3	009 - Fish fork
209/3	010 - Fish knife
143/2,8	011 - Tea spoon
112/2,5	012 - Demitasse spoon
190/3	015 - Sauce spoon
150/2,8	016 - Cake fork
190	018 - Butter knife solid handle
225	021 - Steak knife solid handle
234/3,5	023 - Serving spoon
234/3,5	024 - Serving fork
257/3,5	025 - Cake server
278/3,5	026 - Ladle



Available versions
 18/10 Stainless steel (TT mirror or TB brush finish)
 Silverplated (VT mirror finish)
 Platinum champagne (TC mirror finish)

HOW TO COMPOSE THE CODE
 FINISHING CODE + PATTERN CODE + ITEM CODE

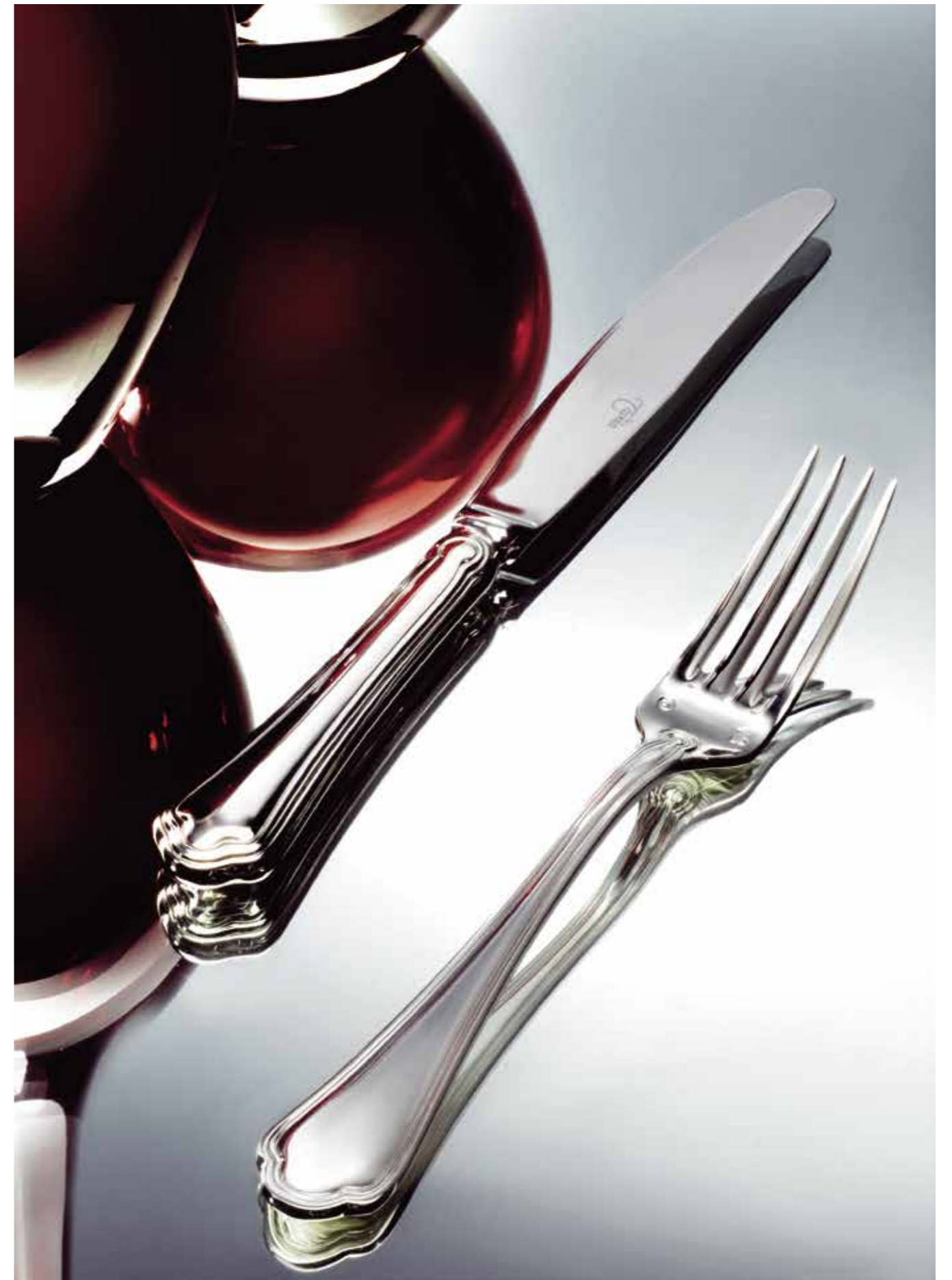



Lucia cod. 10

LEN / THK (mm)	ITEM CODE	DESCRIPTION
204/3,5	001	Table spoon
204/3,5	002	Table fork
243	003	Table knife solid handle
243	004	Table knife hollow handle
187/3	005	Dessert spoon
187/3	006	Dessert fork
223	007	Dessert knife solid handle
223	008	Dessert knife hollow handle
187/3	009	Fish fork
204/3	010	Fish knife
143/2,8	011	Tea spoon
112/2,5	012	Demi-tasse spoon
178/3	014	Soup spoon
190/3	015	Sauce spoon
151/2,8	016	Cake fork
179	018	Butter knife solid handle
221	021	Steak knife solid handle
231/3,5	023	Serving spoon
231/3,5	024	Serving fork
253/3,5	025	Cake server
277/3,5	026	Ladle



Available versions
 18/10 Stainless steel (TT mirror finish)
 Silverplated (VT mirror finish)

HOW TO COMPOSE THE CODE
 FINISHING CODE + PATTERN CODE + ITEM CODE



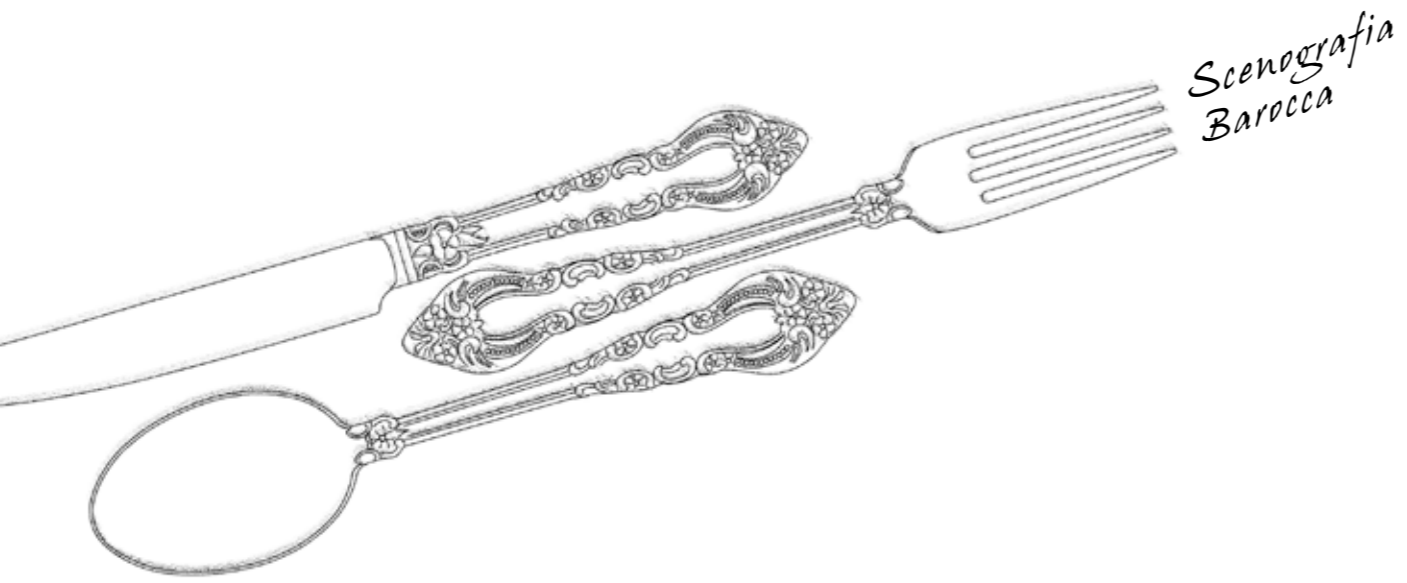

Carmen cod. 09

LEN / THK (mm)	001 - Table spoon	002 - Table fork	003 - Table knife solid handle	005 - Dessert spoon	006 - Dessert fork	007 - Dessert knife solid handle	009 - Fish fork	010 - Fish knife	011 - Tea spoon	012 - Demitasse spoon	016 - Cake fork	018 - Butter knife solid handle	023 - Serving spoon	024 - Serving fork	025 - Cake server	026 - Ladle
	212/3	212/3	244	190/2,8	190/2,8	225	190/2,8	205/2,8	143/2,5	115/2	157/2,5	205	222/3	222/3	248/3	282/3



Available versions

- 18/10 Stainless steel (TT mirror finish)
- Silverplated (VT mirror finish)
- Black titanium (TN mirror finish)
- Venetian gold (TR mirror finish)
- Gold (TO mirror finish)
- Platinum champagne (TC mirror finish)

HOW TO COMPOSE THE CODE
FINISHING CODE + PATTERN CODE + ITEM CODE



SIGNATURE
ESSENTIALS
by LA TAVOLA

Serving items



Carving knife | 37 cm
18/10 st. st. TT14050 - Silverplated VT14050



Carving fork | 30 cm
18/10 st. st. TT14051 - Silverplated VT14051



Serrated cake server | 28,5 cm
18/10 st. st. TT14052 - Silverplated VT14052



Bread knife | 33 cm
18/10 st. st. TT14053 - Silverplated VT14053



Serving buffet fork | 33 cm
18/10 st. st. TT14054 - Silverplated VT14054



Serving buffet spoon | 33 cm
18/10 st. st. TT14054 - Silverplated VT14054



Cake knife | 33 cm
18/10 st. st. TT14057 - Silverplated VT14057



Punch ladle | 40 cm
18/10 st. st. TT14056 - Silverplated VT14056



Yogurt ladle | 26,5 cm
18/10 st. st. TT14058 - Silverplated VT14058



Yuki
Black, Venetian Gold and Gold



Rétro by La Tavola

The newest addition to the La Tavola flatware family is Rétro, the key to designing a tabletop ambiance with a touch of retro style that is warm and inviting for guests.

In addition to stainless steel, Rétro is also available in our three signature titanium and PVD finishes - Gold, Venetian Gold and Platinum Champagne.



● 18 / 10 st. st. (Mirror finish)

● 18 / 10 st. st. (Satin finish)

● 18 / 10 st. st. (Brush finish)



● 18 / 10 st. st. (Rétro finish)

● Silverplated (Mirror finish)

● Silverplated (Satin finish)

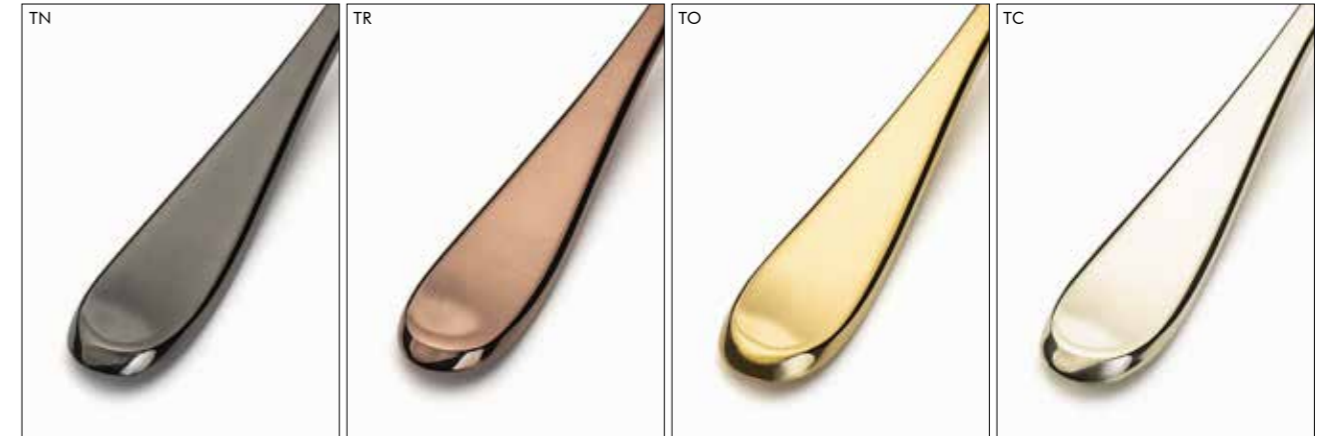

● Black titanium (Mirror finish)

● Venetian gold (Mirror finish)

● Gold (Mirror finish)

● Platinum champagne (Mirror finish)



● Venetian gold (Rétro finish)

● Gold (Rétro finish)

● Platinum champagne (Rétro finish)

Finishings and materials

Made of durable and top-quality stainless steel, the flatware collections designed by La Tavola are naturally crafted for lasting. Creating beautiful pieces of cutlery is an art, and we have been doing it for generations: choosing our flatware means relying on our expertise.

The signature stainless steel flatware collections by La Tavola come in Mirror, Brush and Satin finish: three simple twists that effortlessly add value to each line.

To satisfy the search for a sophisticated yet timeless allure, we keep providing customers with classic Silver-plated pieces of cutlery available in Satin finish or plain mirror finish.

Communicate your style and firm personality with the Titanium and PVD coating applied on our flatware lines: Gold for a bold presentation, Black for a detail-oriented style, Venetian Gold for everlasting romance and Platinum Champagne for unprecedented elegance.

A touch of unicity that won't remain unnoticed.

Our quality Rétro finish is the vintage detail that will turn any room into a cozy place to be: old but gold.

A polished European-style cutlery that won't cease to amaze; have them Titanium and PVD coated in Venetian Gold, Platinum Champagne, Gold or classic stainless steel.

Buffetware

Wonderbuffet
by **la tavola**

La Tavola's Wonderbuffet® collection is the most complete offering for the modern Hotelier.

La Tavola's products incorporate a keen awareness of fluid trends and design styles, whilst making sure to always deliver above operator's expectations in terms of functionality.

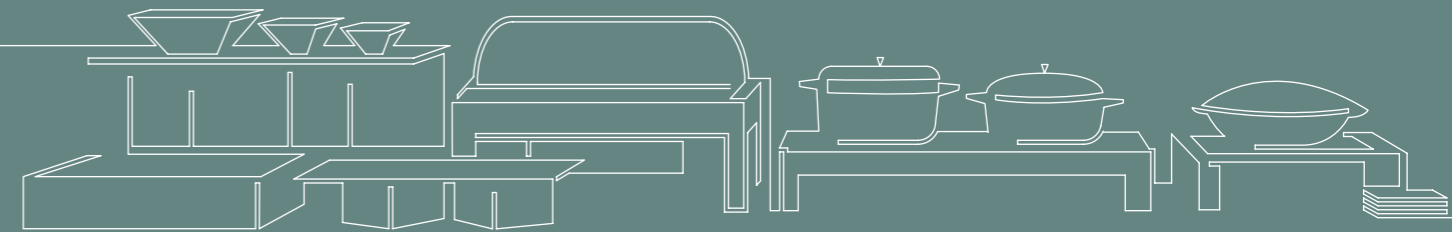



LA TAVOLA'S ITEMS ARE PROUDLY MADE
IN ITALY WITH THE BEST RAW MATERIALS
AND THE LATEST TECHNOLOGY

MODERN BUFFETWARE FOR THE MODERN HOTELIER



THE BEAUTY OF HPL

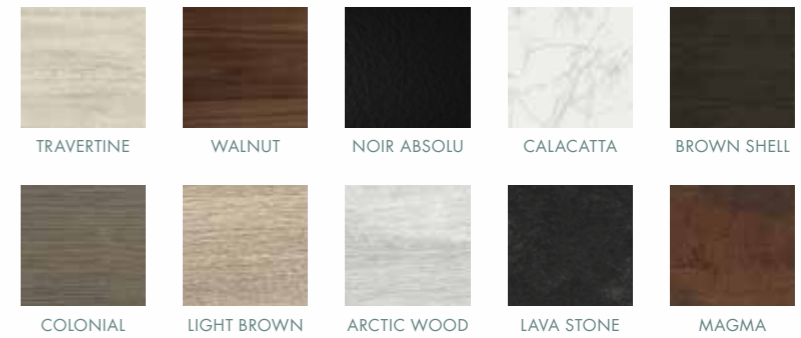

High Pressure Laminate (HPL) is a durable and high-performing material, which is presented in many different stunning finishes

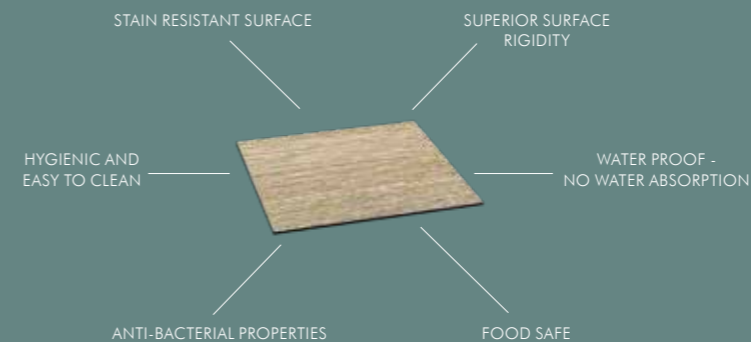

HPL is a high-performing material, durable and lightweight, ideal for the intensive use which is typical in the foodservice industry.

la tavola®

Warm-holding Cold-holding Cooking

Functional solutions for ever-changing needs.

One shared goal: to provide modern hoteliers with an accurate selection of adaptable, performing and qualitatively superior design solutions for their buffets.





■ Magic Chafer

The patented Humidity Control System® makes it ideal for serving any type of food

- » **FOR INDUCTION**
- » Stainless steel 18/10 cover and mechanical hinges
- » Cast aluminium water pan with 5 compartments
- » Condensation recovery system
- » Opens to 90°



MAGIC CHAFER
for induction

L 49 W 46 H 16 cm

2/3 GN

It's recommended to use with a power source ≥ 1000 W



Anti-sliding base - st. st. finish



Anti-sliding base - HPL finish

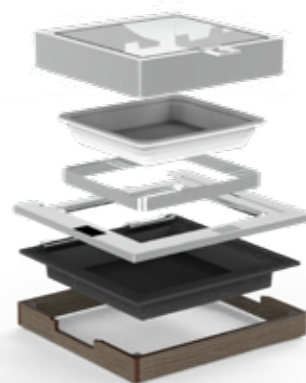

COVER

Magic Chafer is available with or without glass top and in 4 different premium finishes.

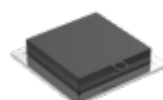

Black Titanium

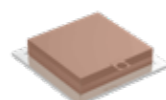

Venetian Gold

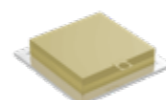

Gold



Platinum Champagne

PORCELAIN FOOD PANS



2/3 GN
1/3 GN

STANDARD FINISHES

- Mirror finish 18/10 st. st.
- Satin finish 18/10 st. st.
- Silverplated

LUXURY FINISHES (Cover only)

- Black titanium
- Venetian gold titanium
- Gold titanium
- Platinum champagne titanium

HPL FINISHES

- Arctic Wood
- Light Brown
- Walnut
- Colonial
- Brown Shell
- Calacatta
- Travertine
- Magma
- Lava Stone
- Noir Absolu



■ Magic Chafer with stand

The patented Humidity Control System® makes it ideal for serving any type of food

- » GEL FUEL, ELECTRIC
- » Stainless steel 18/10 cover and mechanical hinges
- » Cast aluminium water pan with 5 compartments
- » Condensation recovery system
- » Opens to 90°



MAGIC CHAFER
WITH ST. ST. STAND
electric or for fuel burner
L 49 W 46 H 26,5 cm
2/3 GN
700 W | gel fuel



MAGIC CHAFER
WITH HPL STAND
electric or for fuel burner
L 49 W 46 H 26,5 cm
2/3 GN
700 W | gel fuel



COVER

Magic Chafer w/stand is available with or without glass top and in 4 different premium finishes

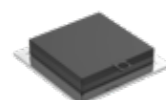

Black Titanium

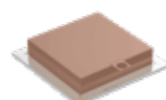

Venetian Gold

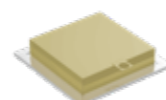

Gold



Platinum Champagne

PORCELAIN FOOD PANS



2/3 GN
1/3 GN

STANDARD FINISHES

- Mirror finish 18/10 st. st.
- Satin finish 18/10 st. st.
- Silverplated

LUXURY FINISHES (Cover only)

- Black titanium
- Venetian gold titanium
- Gold titanium
- Platinum champagne titanium

HPL FINISHES

- Arctic Wood
- Light Brown
- Walnut
- Colonial
- Brown Shell
- Calacatta
- Travertine
- Magma
- Lava Stone
- Noir Absolu

Magic Chafer®

The revolution in chafing dishes



The Magic Chafer is the only chafing dish on the market that provides a scientifically precise Humidity Control System











Humidity Control System®

Thanks to its HCS® patented Water Pan, the Magic Chafer® provides the exact amount of steam necessary for any given dish.

The HCS® Water Pan is divided into 5 compartments, a large central one and 4 smaller ones.

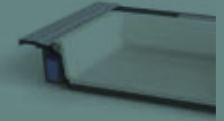
By filling all, some, or none of them, you will be able to control the amount of steam generated by your Magic Chafer®.

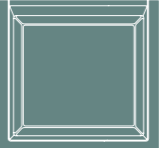
Different dishes require different levels of humidity to maintain their taste, freshness and texture for longer.

TYPE OF FOOD	HUMIDITY REQUIRED	HCS® WATER PAN FILLING OPTIONS	Steam production / water consumption per hour at 75°C
 <p>Rice, steamed vegetables and fish, etc</p>	 <p>High Humidity</p>	 	50 cl /h 500 g /h
 <p>Stewed meat, fish, vegetables with any type of sauce, etc</p>	 <p>Limited Humidity</p>	 	26 cl /h 260 g /h
 <p>Roasted and broiled meats, fried food, baked potatoes, etc</p>	 <p>No Humidity</p>	 	0 cl /h 0 g /h

■ Oyster Chafer

Ideal for main dishes and starches

» **FOR INDUCTION, GEL FUEL, ELECTRIC**

- » Stainless steel 18/10 and ferro-magnetic stainless steel
- » Opens to 100°
- » Stainless steel 18/10 mechanical hinge

- » Condensation recovery system
- » Cover with perforation to release excess steam
- » Food pans are available with or without partition
- » Easy to remove and replace during service
- » Can be used in dry/semi-dry mode



OYSTER CHAFER
for induction
L 45,5 W 40 H 13,5 cm



OYSTER CHAFER
WITH STAND
for fuel burner
L 45,5 W 40 H 25,5 cm
🔥 gel fuel



OYSTER CHAFER
WITH STAND
electric
L 45,5 W 40 H 25,5 cm
⚡ 400 W

DRY DISK



PATENTED!
For use of the Oyster Chafer
in Dry Mode

PORCELAIN FOOD PANS
Ø 36 cm



1/1

1/1
with partition

STANDARD FINISH

- Mirror finish 18/10 st. st.
- Silverplated

LUXURY FINISHES (Cover only)

- Black titanium
- Venetian gold titanium
- Gold titanium
- Platinum champagne titanium



Wonder Chafer

Ideal for main dishes and starches

- » **ELECTRIC, GEL FUEL**
- » Steam collection rim around the cover for condensation recovery
- » Microcast or polyethylene feet to prevent scratching of counter tops
- » The cover, food pans and water pans are removable for ease of operation and maintenance
- » Both stainless steel and porcelain food pans are available
- » Oblong and Round Wonder Chafers open to 170°



WONDER CHAFER
OBLONG
L 70 W 48,5 H 42 cm
700 W | gel fuel



WONDER CHAFER
ROUND
L 55 W 52 H 47 cm
500 W | gel fuel



SOUP STATION
OBLONG
L 70 L 48,5 H 42 cm
700 W | gel fuel



SOUP STATION
ROUND
L 55 W 52 H 45 cm
500 W | gel fuel



OUZI CHAFER
L 92 W 92 H 63 cm
700 W | gel fuel

STANDARD FINISHES

- Mirror finish 18/10 st. st.
- Satin finish 18/10 st. st.
- Silverplated

LUXURY FINISHES

(Legs and handles only)

- Black titanium
- Venetian gold titanium
- Gold titanium
- Platinum champagne titanium

PORCELAIN FOOD PANS



1/1 GN 1/1
1/2 GN 1/1 w/partition
1/3 GN Ø 38 cm
2/3 GN

ST. ST. FOOD PANS



1/1 GN 1/1 Ø 70 cm
1/2 GN Ø 38 cm for Ouzi
1/3 GN Chafer
2/3 GN

SOUP TUREEN



Ø 24 H 23,5 cm
Ø 30 H 27 cm

Classic Chafers

Ideal for main dishes and starches

- » **GEL FUEL, ELECTRIC**
- » Usable with a wide range of food pans of different sizes in 18/10 stainless steel and porcelain
- » The self-bearing structure of the water pan has enabled the realization of a chafer with a reduced number of components
- » Steam collection rim around the outer edges prevents condensation on food when the cover is closed
- » Cover opens up to 170°
- » The cover can be easily removed to facilitate clean-up



CLASSIC CHAFING DISH
OBLONG
L 73,5 W 45 H 42,5 cm
700 W | gel fuel



CLASSIC CHAFING DISH
ROUND
L 61,5 W 49 H 45,5 cm
500 W | gel fuel



CLASSIC SOUP STATION
OBLONG
L 73,5 W 37 H 42 cm
700 W | gel fuel



CLASSIC SOUP STATION
SINGLE
L 61 W 49 H 45 cm
500 W | gel fuel

STANDARD FINISH

Stainless steel 18/10

- Mirror finish 18/10 st. st.

LUXURY FINISHES

- Silverplated
- Mirror finish 18/10 st. st.
- Brass*
- Silverplated
- Brass*

* Only legs and handles in brass

PORCELAIN FOOD PANS



1/1 GN 1/1 1/1
2/3 GN Ø 38 cm w/partition
1/2 GN Ø 38 cm
1/3 GN

ST. ST. FOOD PANS



1/1 GN 1/1 1/2
2/3 GN Ø 38 cm
1/2 GN
1/3 GN
1/4 GN

SOUP TUREEN



Ø 24 H 23,5 cm
Ø 30 H 27 cm



■ Warming Plate

Ideal for any type of food

- » **ELECTRIC**
- » Warm-Holding unit suitable for containers of any material
- » Digital display with temperature control and feedback
- » Black Schott Ceran® glass
- » Transparent PETG cover with INOX frame
- » Scratch resistant surface



WARMING PLATE

L 61,2 W 43,2 H 11 cm

1/1 GN

⚡ 675 W

L 78,2 W 43,2 H 11 cm

1/1+1/3 GN

⚡ 900 W



WARMING PLATE WITH COVER

L 61,2 W 43,2 H 23,6 cm

1/1 GN

⚡ 675 W

L 78,2 W 43,2 H 23,6 cm

1/1+1/3 GN

⚡ 900 W

CHAIN LINK SYSTEM: Up to 5 products (1/1 GN) | Up to 4 products (1/1+1/3 GN)

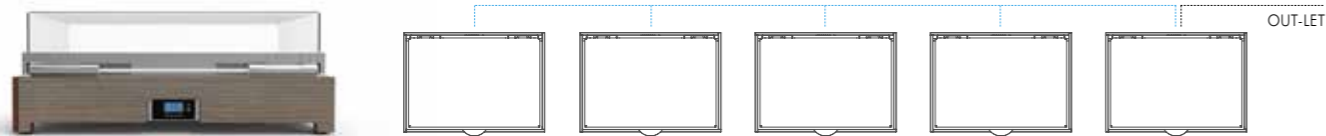

PORCELAIN FOOD PANS



1/1 GN
1/2 GN
1/3 GN
2/3 GN

COCOTTES



TAJINE



STONE BACON TRAYS



L 16 W 53 H 2,5 cm

HPL FINISHES

- Arctic Wood
- Light Brown
- Walnut
- Colonial
- Brown Shell
- Calacatta
- Travertine
- Magma
- Lava Stone
- Noir Absolu





■ Carving Station

Presentation and carving of roasts and various grilled meats

- » **ELECTRIC**
- » Removable black granite top
- » Excess liquid collection system with recovery tank
- » Uniform temperature distribution
- » Easy access to temperature regulators
- » Maximum temperature up to 90° C (as measured on the granite top)



CARVING STATION WITH HEAT LAMP
L 59,6 W 59,6 H 46 cm
⚡ 500 W



CARVING STATION PRO
L 74 W 53 H 13 cm
1/1 GN
⚡ 2x 700 W



1-2 HEAT LAMPS for Carving Station Pro
W 27 L 20 H 70 cm
⚡ 250 W (each lamp)

ST.ST. FINISHES

- Mirror finish 18/10 st. st.
- Satin finish 18/10 st. st.

HPL FINISHES *Only for Carving Station Pro*

- Arctic Wood
- Light Brown
- Walnut
- Colonial
- Brown Shell
- Calacatta
- Travertine
- Magma
- Lava Stone
- Noir Absolu



Carving Station Pro - Recovery tank

■ Warming Tray

Bread, pizza & focaccia, croissants and warm desserts

- » **ELECTRIC**
- » 50°C maximum heating
- » 1/1 GN size
- » Can be used with La Tavola's Display Trays, with or without cover



WARMING TRAY
L 54 W 33 H 4 cm
1/1 GN
⚡ 40 W



A Warming Tray is made to measure to fit within a La Tavola's Display Trays

STANDARD FINISH Stainless steel 18/10

- New Ice finish 18/10 st. st.



Available with Low and High Display Trays, with or without transparent cover





■ Dry Chafer

Ideal for deep fried food, tempura, roasts, baked or grilled vegetables

» **FOR INDUCTION**

- » Uniform temperature distribution
- » Two mechanical hinges

» Works with non-induction-ready ceramic food pans

» Induction plate not included



DRY CHAFER
for induction
WITH GLASS COVER
L 40,5 W 40,5 H 15 cm
2/3 GN



DRY CHAFER
for induction
WITH ST. ST COVER
L 40,5 W 40,5 H 15 cm
2/3 GN

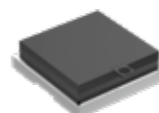

Black Titanium

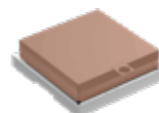

Venetian Gold

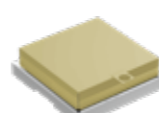

Gold



Platinum Champagne

ST.ST. FINISHES

- Mirror finish 18/10 st. st.
- Satin finish 18/10 st. st.

LUXURY FINISHES (Cover only)

- Silverplated
- Black titanium
- Venetian gold titanium
- Gold titanium
- Platinum champagne titanium

PORCELAIN FOOD PANS



1/3 GN
2/3 GN

■ Mini Chafer

Ideal for sauces

» Heat source: **GEL FUEL**



MINI CHAFER
for fuel burner
L 22 W 21 H 11 cm
gel fuel



DUAL MINI CHAFER
for fuel burner
L 49 W 29 H 11 cm
gel fuel



Cover holder
L 15 W 15 H 21 cm



Soup ladle holder
L 15 W 15 H 21 cm

ST.ST. FINISHES

- Mirror finish 18/10 st. st.
- Satin finish 18/10 st. st.

HPL FINISHES

- Arctic Wood
- Light Brown
- Walnut
- Colonial
- Brown Shell
- Calacatta
- Travertine
- Magma
- Lava Stone
- Noir Absolu

COCOTTES
Ø 18 cm



Black



Graphite Grey



Cherry



■ Induction Warming Top

Ideal for chafer and any induction compatible pan or container

- » **INDUCTION**
- » Temperature management with 12 levels of setting
- » Temperature range: 104-203 °F / 40-95 °C
- » Black Schott Ceran® glass

HPL FINISHES

- Arctic Wood
- Light Brown
- Walnut
- Colonial
- Brown Shell
- Calacatta
- Travertine
- Magma
- Lava Stone
- Noir Absolu

Examples of induction compatible pan or container available



INDUCTION WARMING TOP

L 39 W 39 H 11 cm

300 W

2/3 GN



DUAL INDUCTION WARMING TOP

L 62 W 39 H 11 cm

600 W

1/1 GN

■ Multi Point Induction Warming Plate

Ideal for chafer and any induction compatible pan or container

- » **INDUCTION**
- » Temperature range: 122-212 °F / 50-100 °C
- » Temperature displayed on digital display underneath Ceran glass
- » "No pan no heat" technology for minimal energy wastage
- » Suitable for use with up to 4 induction-ready containers
- » Multi-point induction area 80 x 34 cm

ST.ST. FINISHES

- Mirror finish 18/10 st. st.
- Satin finish 18/10 st. st.

HPL FINISHES

- Arctic Wood
- Light Brown
- Walnut
- Colonial
- Brown Shell
- Calacatta
- Travertine
- Magma
- Lava Stone
- Noir Absolu

Examples of induction compatible pan or container available



Oyster Chafer



Cocottes



Ceramic Tajine



MULTI POINT INDUCTION WARMING PLATE

L 93,8 W 47,7 H 12,3 cm

1500 W



Hot&Cold Plate

Ideal for cold and warm holding of finger food and plated dishes

» **ELECTRIC**

- » Temperature range:
 - 90 °C / 194 °F
 - -5 °C / 23 °F

- » Digital temperature control and feedback
- » Stainless Steel structure with HPL panels
- » Removable cover (optional)



HOT&COLD PLATE

L 57,2 W 37,2 H 20 cm

1/1 GN

800 W

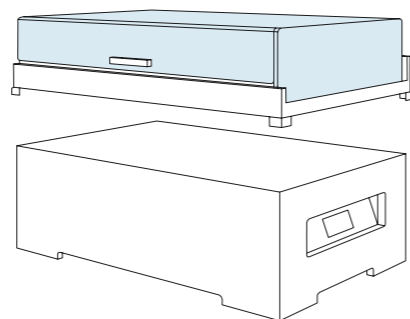

Removable cover is an optional additional component that can be easily placed and removed.



PORCELAIN FOOD PANS



1/1 GN
1/2 GN
1/3 GN
2/3 GN

COCOTTES & TAJINE



Black



Cherry



Graphite Grey



Ceramic Tajine

HPL FINISHES

- | | |
|---------------|---------------|
| ● Arctic Wood | ● Calacatta |
| ● Light Brown | ● Travertine |
| ● Walnut | ● Magma |
| ● Colonial | ● Lava Stone |
| ● Brown Shell | ● Noir Absolu |



Cooling Plate

Ideal for cold finger food, cold cuts, sushi, fruit & salads, cold dips

- » **EUTECTIC** cooling
- » The Eutectic Cooling Plate is a versatile platform that can be easily adapted for different purposes
- » Eutectic cooling technology - no ice or electricity required
- » Eutectic plate releases cold for up to 5 hours
- » Place the eutectic unit in a freezer at -18°, for 18 hours before use
- » Also available with transparent PETG cover reinforced with st.st. frame

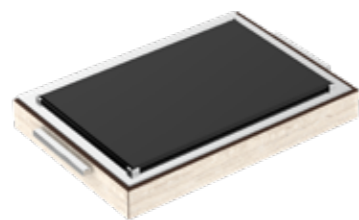

COOLING PLATE

L 71 W 46,4 H 9 cm

1/1 GN

L 85 W 54 H 9 cm

1/1+1/3 GN

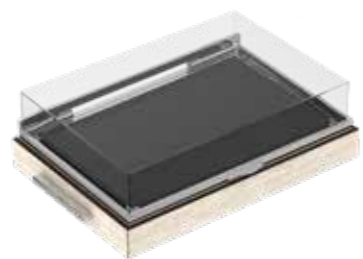

COOLING PLATE WITH COVER

L 71 W 48,3 H 20,7 cm

1/1 GN

L 85 W 55,5 H 20,7 cm

1/1+1/3 GN

INTERCHANGEABLE USE
Set-up can be changed with ease from one functionality to the other

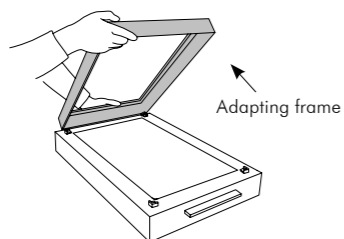

Adapting frame

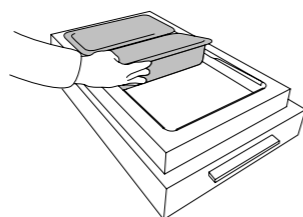

Adapting Frame



For Food Pans

GLASSES



1/1 GN
1/1+1/3 GN

PORCELAIN FOOD PANS



1/1 GN
1/2 GN
1/3 GN
2/3 GN

JAPANESE BOWL



Ø 11
H 6,5 cm
0,2 lt.

ST.ST. FINISHES

- Mirror finish 18/10 st. st.
- Satin finish 18/10 st. st.

HPL FINISHES

- Arctic Wood
- Light Brown
- Walnut
- Colonial
- Brown Shell
- Calacatta
- Travertine
- Magma
- Lava Stone
- Noir Absolu





■ Chill-it Cooling System

Ideal for ice-cream and sorbet

- » **EUTECTIC** cooling technology - no ice or electricity required
- » Stackable, double walled Chill-It pans containing food safe gel

- » Chill-It food pans release cold for up to 4 hours
- » Also available with transparent PETG cover reinforced with st.st. frame



CHILL-IT COOLING SYSTEM
L 60 W 40 H 17 cm
1/1 GN



CHILL-IT COOLING SYSTEM WITH COVER
L 60 W 40 H 23 cm
1/1 GN

ST.ST. FINISHES

- Mirror finish 18/10 st. st.
- Satin finish 18/10 st. st.

HPL FINISHES

- Arctic Wood
- Light Brown
- Walnut
- Colonial
- Brown Shell
- Calacatta
- Travertine
- Magma
- Lava Stone
- Noir Absolu

CHILL-IT PANS

- 1/3 GN 1/3 GN w/partition 1/2 GN
(also available with transparent cover)



■ Cold Well

Ideal for fruits, salads, cold dips, yoghurt, bircher muesli

- » **EUTECTIC** cooling
- » Eutectic plate releases cold for up to 5 hours
- » H 10 cm food pans available for high food volume capacity

- » Transparent PETG cover reinforced with st.st. frame
- » Easily replaceable transparent cover



COLD WELL
L 71 W 48,3 H 24 cm
1/1 GN
L 85 W 55,5 H 24 cm
1/1+1/3 GN

ST.ST. FINISHES

- Mirror finish 18/10 st. st.
- Satin finish 18/10 st. st.

HPL FINISHES

- Arctic Wood
- Light Brown
- Walnut
- Colonial
- Brown Shell
- Calacatta
- Travertine
- Magma
- Lava Stone
- Noir Absolu

PORCELAIN FOOD PANS

- | | |
|---------|----------|
| | |
| H 10 cm | H 6,5 cm |
| 1/2 GN | 1/1 GN |
| 1/3 GN | 1/2 GN |
| 2/3 GN | 1/3 GN |
| | 2/3 GN |



■ Cooling Tray

Ideal for cold finger food, cold cuts, sushi

- » **EUTECTIC** cooling technology - no ice or electricity required
- » Stainless steel 18/10 mirror finish base
- » Eutectic plate releases cold for up to 4 hours
- » Can be used with La Tavola's Display Trays, with or without cover

ST.ST. FINISHES

- New Ice finish 18/10 st. st.



Available with Low and High **Display Trays**, with or without transparent cover



Oblong
COOLING TRAY
L 55 W 34 H 4,8 cm
1/1 GN



A Cooling Tray is made to fit within a La Tavola's Display Trays

■ Oyster & Fruit de mer Display

Ideal for food-on-ice concept, oysters and raw seafood

- » HPL finish walls
- » Walls are also available in stainless steel "New Ice" 18/10
- » Polycarbonate ice container with st. st. drainer

ST.ST. FINISHES

- 18/10 st. st. New Ice

HPL FINISHES

- Arctic Wood
- Light Brown
- Walnut
- Colonial
- Brown Shell
- Calacatta
- Travertine
- Magma
- Lava Stone
- Noir Absolu



Oyster & Fruit de mer
DISPLAY
L 64,5 W 53 H 23 cm
2/1 GN



■ Bowls Holder

Ideal for yogurt, muesli, fresh cheese, cold dips

- » **EUTECTIC** cooling technology - no ice or electricity required
- » Eutectic plate releases cold for up to 4 hours
- » Stainless steel 18/10 mirror finish base
- » Glass bowls with methacrylic cover and opening
- » Can be used with La Tavola's Display Trays



BOWLS HOLDER

L 56,5 W 36 H 8,1 cm

1/1 GN

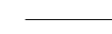

Bowls Holder is made to measure to fit within a La Tavola's Display Trays

ST.ST. FINISHES

- Mirror finish 18/10 st. st.



GLASS BOWL
w/ methacrylic cover
with hinge

Ø 23,5 (with cover)
Ø 22,5 (without cover)

■ Pot and Butter Cooler

Ideal for yogurt and butter

- » **EUTECTIC** cooling technology - no ice or electricity required
- » Eutectic plate releases cold for up to 4 hours
- » Stainless steel 18/10 mirror finish base

ST.ST. FINISHES

- Mirror finish 18/10 st. st.

Pot Cooler is available with Low and High **Display Trays**, with or without transparent cover

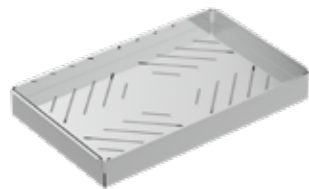

POT COOLER

L 55 W 34 H 6,8 cm

1/1 GN

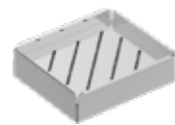

BUTTER COOLER

L 21 W 18,5 H 5,5 cm



■ Cold Drinks

Ideal for fruit juice and cold beverage

- » **EUTECTIC** cooling technology - no ice or electricity required
- » Eutectic plate releases cold for up to 4 hours
- » Stainless steel 18/10 mirror finish base



ST.ST. FINISHES

- Mirror finish 18/10 st. st.



COLD DRINKS

Eutectic Set
6 pcs.
L 46,4 W 37 H 12,6 cm

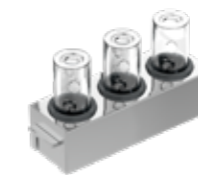

COLD DRINKS

Eutectic Set
3 pcs.
L 46,4 W 18,5 H 12,6 cm



GLASS JUG 1 Lt.
WITH TRANSPARENT CAP
Ø 9 h 23

■ Wok station

- » **INDUCTION POWERED**
- » Cooking area: Ø 31 cm
- » Pan size: Ø 36 cm
- » Digital controls for regulation of temperature and other settings
- » Automatic safety switch-off function
- » Booster function for quick heating
- » Timer function



WOK
L 62 W 49 H 20 cm
⚡ 3700 W
⚡ 2700 W

■ Cooking station

- » **INDUCTION POWERED**
- » Cooking areas:
Ø 145 ⚡ 1400 W / 1100 W
Ø 210 ⚡ 2300 W / 1600 W
- » All power (⚡ 3700 W / 2700 W) can be directed on one large pan
- » Automatic safety switch-off function
- » Booster function for quick heating
- » Timer function



DUAL COOKING PLATE
L 62 W 49 H 13 cm
⚡ 3700 W
⚡ 2700 W

■ Grill Teppanyaki station

- » **INDUCTION POWERED**
- » Cooking area: L 30 W 47 cm
⚡ 3700 W (1400 W + 2300 W)
⚡ 2700 W (1100 W + 1600 W)
- » Booster function for quick heating
- » Timer function



GRILL/TEPPANYAKI
L 62 W 49 H 13 cm
⚡ 3700 W
⚡ 2700 W

Touch screen control panel with 9 power settings, safety lock and timer function.
Activate commands with a simple touch and get feedback by control lights.
Power levels (1-9) can be switched by sliding a finger on the "slider" or by pressing your finger directly on the chosen level.



HPL FINISHES

- | | | | | |
|---------------|------------|---------------|--------------|---------------|
| ● Arctic Wood | ● Walnut | ● Brown Shell | ● Travertine | ● Lava Stone |
| ● Light Brown | ● Colonial | ● Calacatta | ● Magma | ● Noir Absolu |



la tavola®

Market displays

Modern and elegant complements to a sophisticated interior decoration.





MARKET STAND

L 60 W 72 H 26 cm



MINI MARKET STAND

L 60 W 40 H 18 cm

Some examples of configurations available



PORCELAIN FOOD PANS
1/1GN 1/2GN 2/3GN
1/3GN 2/4GN



PORCELAIN FOOD PANS
1/1 GN 1/2 GN 1/3 GN



FLOWER POTS

L 60 W 72 H 26 cm
30 bowls capacity



MINI FLOWER POTS

L 60 W 40 H 18 cm
15 bowls capacity

CERAMIC JAPANESE BOWLS
Ø 11 H 6,5 cm 0,2 lt



FLYOVER

L 54 W 47 H 11 cm
3 bowls capacity

PREMIUM QUALITY
CERAMIC BOWLS
Ø 24 H 9 cm 2 lt



THE TREE RISER

L 60 W 60 H 40 cm

FINISHES

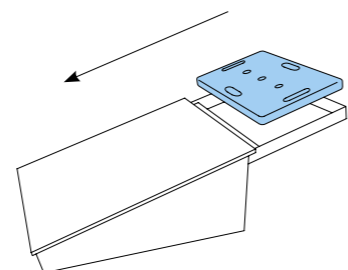
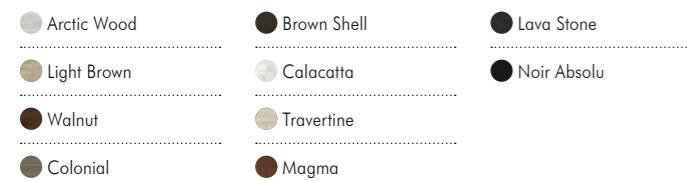

Cooling System

The hidden eutectic plate is placed in a st. st. tray underneath the bowls / food pans

FINISHES





2-LEVEL DISPLAY
L 60 W 40 H 51 cm



3-LEVEL DISPLAY
L 60 W 40 H 76 cm



Multi-level Displays

STRUCTURE FINISHES

- St. st. satin finish
- Powder coating black
- Powder coating copper/bronze
- Powder coating gold

HPL FINISHES

- Arctic Wood
- Walnut
- Brown Shell
- Travertine
- Lava Stone
- Light Brown
- Colonial
- Calacatta
- Magma
- Noir Absolu

How does it work?

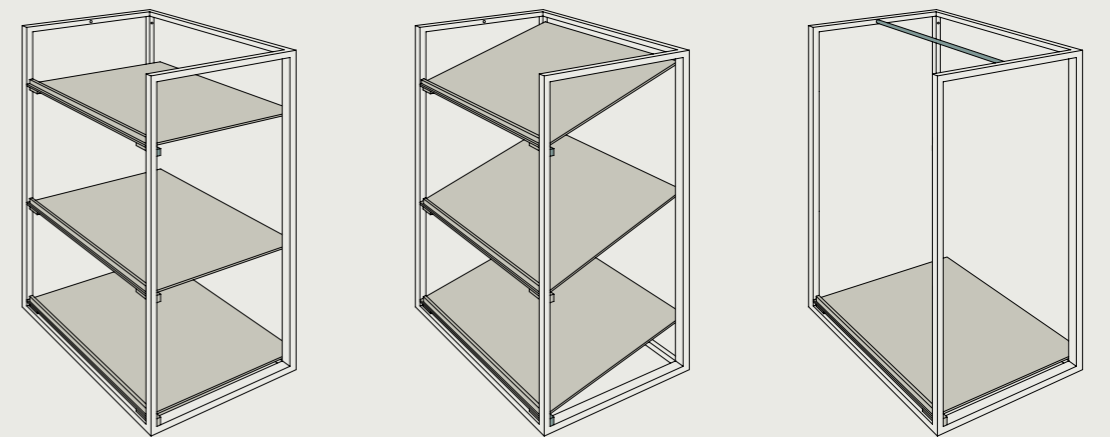

Each level can be easily reclined or removed according to the display requirements.
Simply remove the two upper levels and place the bar in the middle to use it as a hanger for a dynamic display setup.



MARKET BOX LARGE
L 53 W 33 H 10 cm



MARKET BOX SMALL
L 33 W 33 H 10 cm



MARKET BOX LARGE WITH 6 PARTITION
L 53 W 33 H 10 cm



MARKET BOX SMALL WITH 4 PARTITION
L 33 W 33 H 10 cm



MARKET TRAY LARGE
L 53 W 33 H 7 cm



MARKET TRAY LARGE WITH 7 PARTITION
L 53 W 33 H 7 cm



MARKET TRAY LARGE WITH 4 PARTITION
L 53 W 33 H 7 cm



MARKET TRAY SMALL
L 33 W 33 H 7 cm

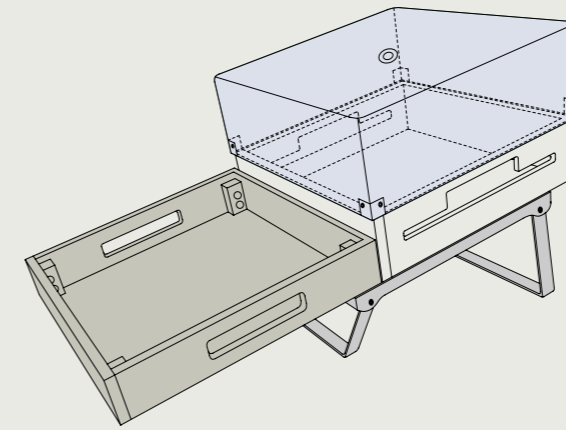

Combine the elements to create a display setup that satisfies your needs.

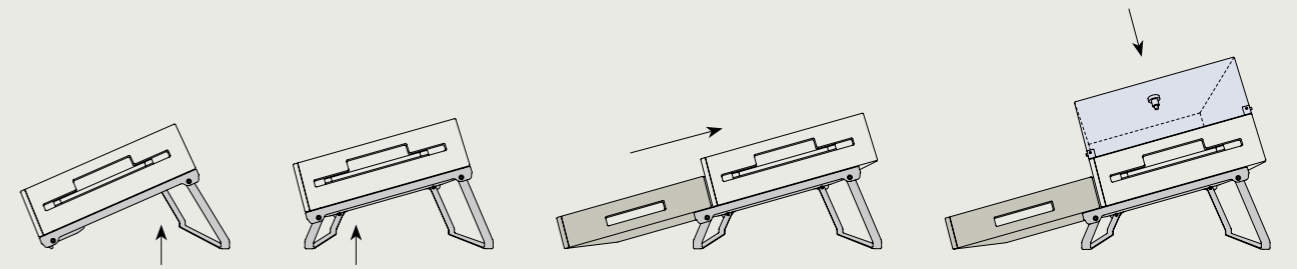

The adaptable boxes and trays are designed to allow for maximum freedom of movement: deploy the stand and adjust its legs to create different display combinations and place the trays and boxes on top or half-hooked.

Come with or without cover, each piece can transform as your service demands do.

Market Boxes and Trays



TRANSPARENT PETG COVERS



For large Market box/tray
L 54 W 34 H 7 cm



For small Market box/tray
L 34 W 34 H 7 cm

BOX/TRAY SUPPORT

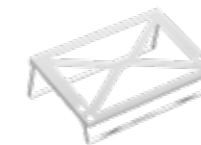

For large Market box/tray
L 53 W 34 H 16,5 cm



For small Market box/tray
L 33 W 34 H 16,5 cm

FINISHES

- Arctic Wood
- Light Brown
- Walnut
- Colonial
- Brown Shell
- Calacatta
- Travertine
- Magma
- Lava Stone
- Noir Absolu



Market Elevation System

The Market Elevation System is a simple tool that allows for the creation of a functional and stunning buffet presentation. 4 different heights, smoked or clear glass pieces to create junctions, neutral or hot/cold tops to hold any type of food.

The main material used is HPL, a very durable, eco-friendly and hygienic material

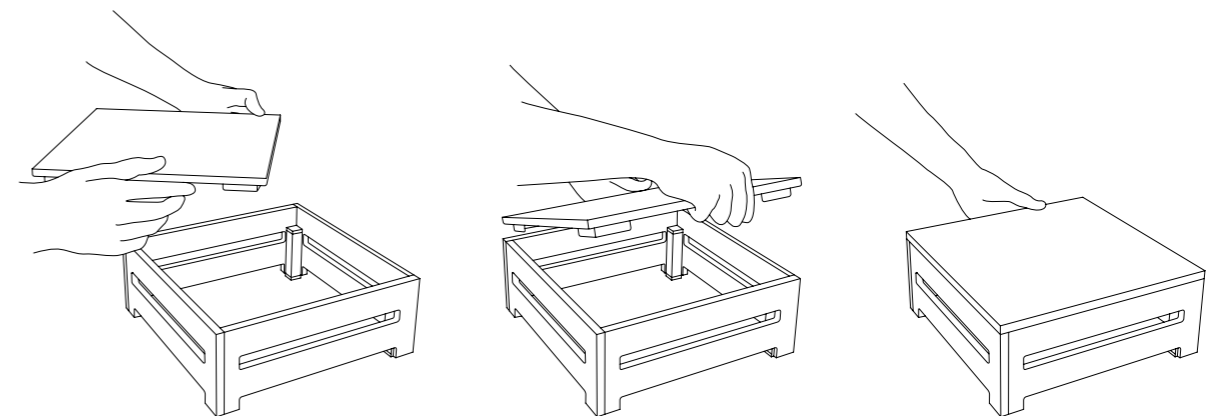

Elevations and Crosses

ELEVATIONS



**2-LEVEL ELEVATION
SMALL**
L 33 W 33 H 13 cm



**2-LEVEL ELEVATION
LARGE**
L 53 W 33 H 13 cm



**4-LEVEL ELEVATION
SMALL**
L 33 W 33 H 26 cm



**4-LEVEL ELEVATION
LARGE**
L 53 W 33 H 26 cm



**6-LEVEL ELEVATION
SMALL**
L 33 W 33 H 39 cm



**8-LEVEL ELEVATION
SMALL**
L 33 W 33 H 52 cm

CROSSES



HIGH MARKET RISER
L 33 W 33 H 38,5 cm



LOW MARKET RISER
L 33 W 33 H 25 cm

CROSSES TOPS

Available in transparent hardened glass, smoked hardened glass or HPL finishes



50 x 50 cm Ø 50 cm 57 x 36,5 cm 80 x 30 cm

TRANSPARENT OR SMOKED GLASS CONJUNCTION ELEMENTS

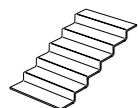

L 44 W 24,5
H 19 cm

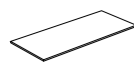

L 55 W 24,4
H 1 cm



L 85 W 24,4
H 1 cm



L 60,2 W 24,4
H 1 cm



L 64,6 W 24,4
H 1 cm

FINISHES

- Arctic Wood
- Light Brown
- Walnut
- Colonial
- Brown Shell
- Calacatta
- Travertine
- Magma
- Lava Stone
- Noir Absolu

Elevation Tops

GLASS TOPS

Glass available in black or white



HPL TOPS

Available in all finishes



L 33 W 33 H 2,4 cm



L 53 W 33 H 2,4 cm
FOR LARGE ELEVATIONS

WARMING TOPS

Glass available in black or white

COOLING TOPS

Glass available in black or white

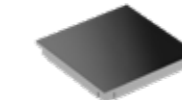

L 33 W 33 H 4,5 cm



L 53 W 33 H 4,5 cm
FOR LARGE ELEVATIONS

WARMING PAN TOPS

Electric heating

COOLING PAN TOPS

Eutectic cooling

All GN food pans available.
Transparent covers can be applied only
on 1/2 GN food pans.



L 33 W 33 H 4,5 cm



L 53 W 35 H 4,5 cm
FOR LARGE ELEVATIONS

COCOTTE TOPS

Ceramic cocotte Ø 28 cm
Cast iron cocotte Ø 26 cm



L 33 W 33 H 4,5 cm



L 53 W 33 H 4,5 cm
FOR LARGE ELEVATIONS

TRANSPARENT PETG COVERS



L 34 W 34 H 12 cm



L 53 W 33 H 12 cm
FOR LARGE ELEVATIONS

la tavola®

Risers

Elevation achieved with risers is the perfect choice for creating a dynamic presentation that will additionally boost the guests' appreciation of your buffet.

La Tavola offers a variety of options in terms of style, materials, heights and combinations.

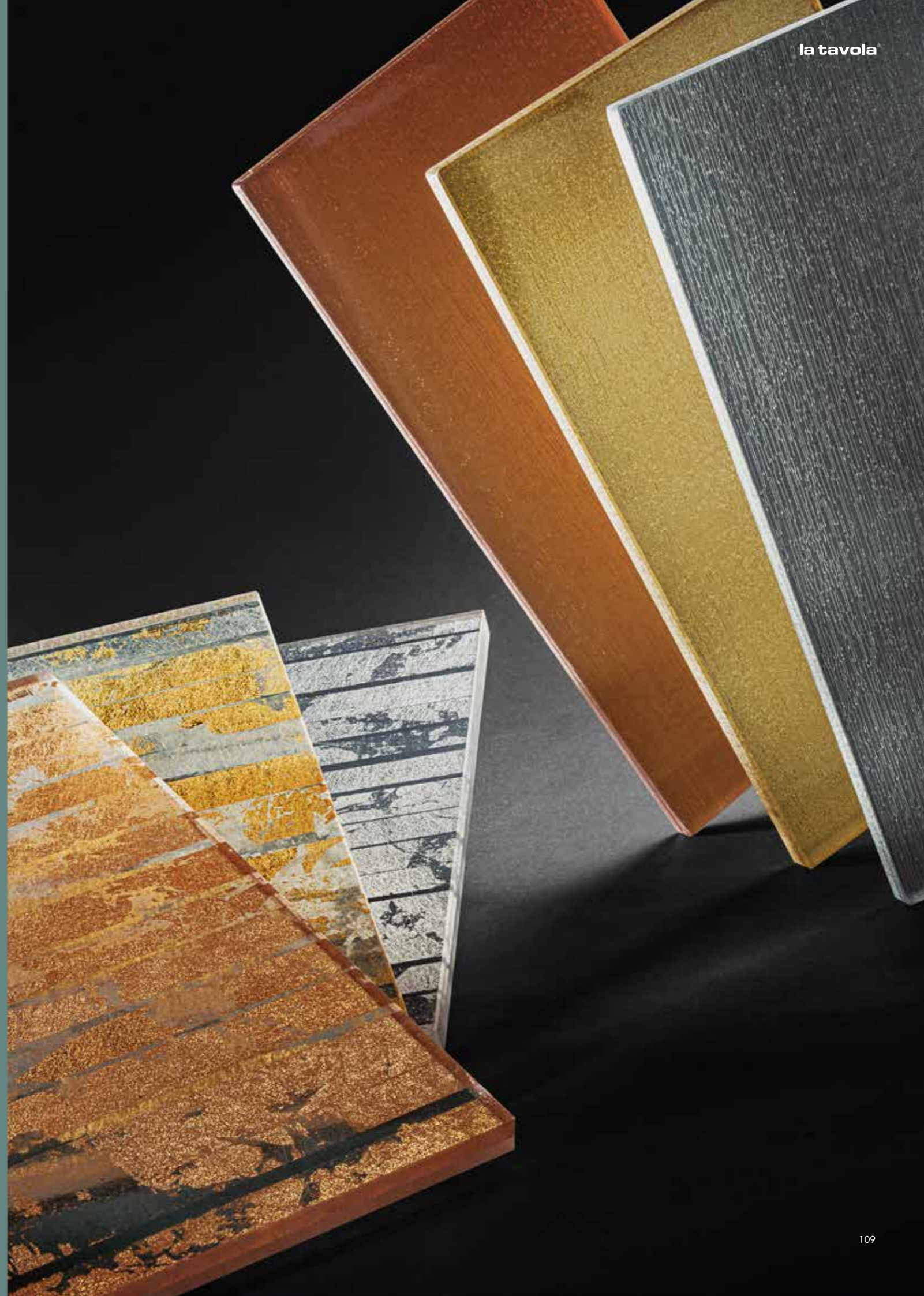



Gold Flash finish



Thatch finish



ORGANIC FINISHES

Made from specially-formulated co-polyester resin housing interlayers of natural and metallic materials. Extremely resistant to breakage. Scratch resistant.



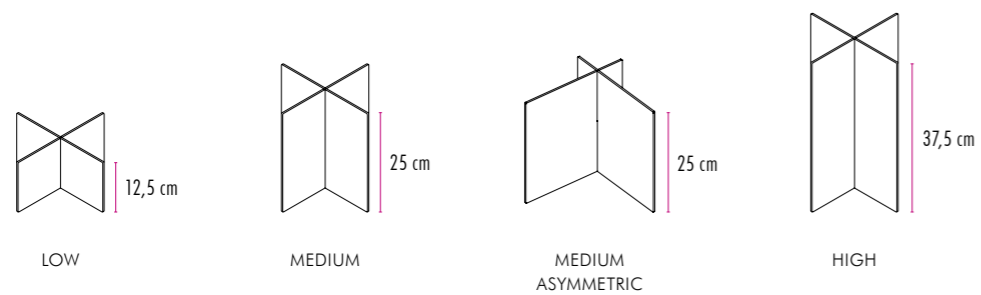

Organic & Mineral Risers



ORGANIC FINISHES

-  Gingko
-  Grass
-  Sprout
-  Thatch

MINERAL FINISHES

-  Gold
-  Gold Flash
-  Silver
-  Silver Flash
-  Copper
-  Copper Flash



Silver Flash, Copper Flash and Gold Flash finish



MINERAL FINISHES

The Mineral Risers collection offers a variety of stylish and elegant finishes - discover the stunning combinations. A collection that is sure to make a statement.

LOW-IMPACT PRODUCTS

La Tavola's Organic and Mineral Risers have the added benefit of being made from a specially-formulated co-polyester resin that combines performance with environmental responsibility. Eco-resin incorporates 40% pre-consumer recycled content without compromising aesthetics or overall physical properties, is compatible with one of the largest post-consumer recycling streams, and is GREENGUARD® Indoor Air Quality and Breeam Certified.



Sprout finish



Ginkgo finish



Grass finish

Ginkgo, Sprout and Grass finish



Our products bring to life hand-crafted materials from artisans around the world.

La Tavola uses beautiful indigenous products customized for the production of the Riser's panels, encouraging the development of a sustainable market for the artisans and the communities to which they belong.

THESE MATERIALS ARE ENCAPSULATED
IN THE ORGANIC AND MINERAL RISERS,
CREATING MODERN DESIGN AESTHETICS.



Copper Flash finish



Silver Flash finish



Silver and Gold finish



Cube Risers



L 25 W 25 H 11 cm

L 25 W 25 H 22 cm

L 25 W 25 H 33 cm

ST. ST. FINISHES

- Mirror finish 18/10 st. st.



Corner Risers



L 20 W 20 H 11 cm

L 20 W 20 H 22 cm

L 20 W 20 H 33 cm

ST. ST. FINISHES

- Mirror finish 18/10 st. st.
- 18/10 st. st. New Ice

TITANIUM FINISHES

- Black titanium
- Venetian gold titanium
- Gold titanium
- Platinum champagne titanium



Cut Risers

"LACE" CUT RISERS



L 20 W 20 H 11 cm L 20 W 20 H 22 cm L 20 W 20 H 33 cm

"CHECKERS" CUT RISERS



L 20 W 20 H 11 cm L 20 W 20 H 22 cm L 20 W 20 H 33 cm

ST. ST. FINISHES

● Mirror finish 18/10 st. st.

TITANIUM FINISHES

● Black titanium

● Gold titanium

● Venetian gold titanium

● Platinum champagne titanium



High&Low Risers

ROUND STAND



Ø 17 H 13 cm Ø 17 H 17 cm Ø 17 H 21 cm

OBLONG STAND



L 36 W 24 H 12 cm L 36 W 24 H 18 cm L 36 W 24 H 24 cm
L 49 W 29 H 12 cm L 49 W 29 H 18 cm L 49 W 29 H 24 cm
L 63 W 36 H 12 cm L 63 W 36 H 18 cm L 63 W 36 H 24 cm

ST. ST. FINISHES

● Mirror finish 18/10 st. st.

Risers Tops



GLASS TOPS

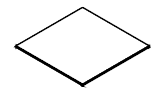

50 x 50 cm



Ø 50 cm

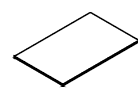

57 x 36,5 cm

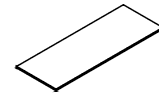

80 x 30 cm



Tempered glass: This type of glass is automotive-grade. It is very strong and scratch-resistant, and in case of breakages it minimizes the risk of injury.

- Transparent hardened glass
- Smoked hardened glass



HPL TOPS

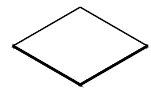

50 x 50 cm



Ø 50 cm

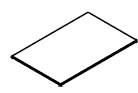

57 x 36,5 cm

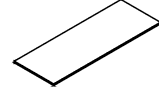

80 x 30 cm



The tiles are made of HPL, a high-performing material ideal for the intensive use which is typical in the foodservice industry. HPL tops are durable and lightweight.

- Arctic Wood
- Light Brown
- Walnut
- Colonial
- Brown Shell
- Calacatta
- Travertine
- Magma
- Lava Stone
- Noir Absolu



CERAMIC TILES TOPS

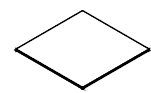

50 x 50 cm



Ø 50 cm

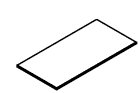

60 x 30 cm

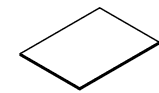

60 x 45 cm



Ceramic pressed at high power (4000 tons) and then subjected to extreme temperatures (up to 1700°C), making them virtually 100% waterproof, stain resistant and extremely long lasting.

- Rust
- Marquinia Black
- Black Lava
- Sand
- Calacatta Pure White



RISERS

Organic/Mineral/HPL Risers

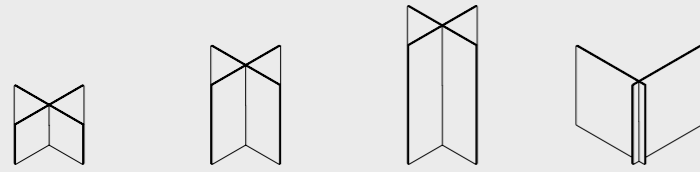

L 23,5 W 23,5 H 12,5 cm L 23,5 W 23,5 H 25 cm L 23,5 W 23,5 H 37,5 cm L 23,5 W 23,5 H 25 cm

Cube Risers

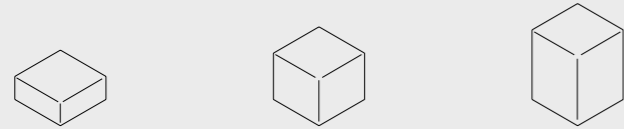

L 25 W 25 H 11 cm L 25 W 25 H 22 cm L 25 W 25 H 33 cm

Corner Risers



L 20 W 20 H 11 cm L 20 W 20 H 22 cm L 20 W 20 H 33 cm

Cut Risers "Lace"

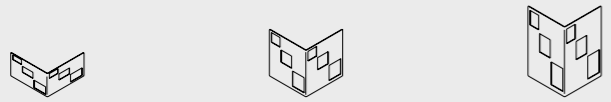

L 20 W 20 H 11 cm L 20 W 20 H 22 cm L 20 W 20 H 33 cm

Cut Risers "Checkers"



L 20 W 20 H 11 cm L 20 W 20 H 22 cm L 20 W 20 H 33 cm

MATERIALS & FINISHES

ORGANIC

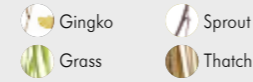

MINERAL



HPL

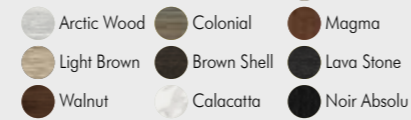

Mirror finish 18/10 st. st.

Mirror finish 18/10 st. st.
18/10 st. st. New Ice
Black titanium
Venetian gold titanium
Gold titanium
Platinum champagne titanium

Mirror finish 18/10 st. st.
Black titanium
Venetian gold titanium
Gold titanium
Platinum champagne titanium

Mirror finish 18/10 st. st.
Black titanium
Venetian gold titanium
Gold titanium
Platinum champagne titanium

RISERS

High & Low Risers "Round"



Ø 17 H 13 cm Ø 17 H 17 cm Ø 17 H 21 cm

High & Low Risers "Square"



L 36 W 24 H 12 cm L 36 W 24 H 18 cm L 36 W 24 H 24 cm
L 49 W 29 H 12 cm L 49 W 29 H 18 cm L 49 W 29 H 24 cm
L 63 W 36 H 12 cm L 63 W 36 H 18 cm L 63 W 36 H 24 cm

RISER TOPS

Transparent or Smoked Glass tops

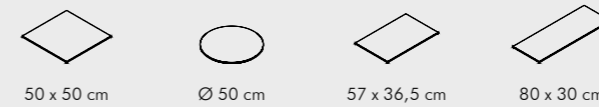

50 x 50 cm Ø 50 cm 57 x 36,5 cm 80 x 30 cm

HPL tops

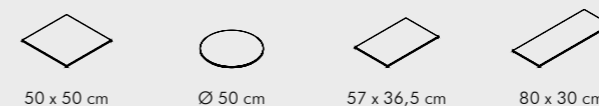

50 x 50 cm Ø 50 cm 57 x 36,5 cm 80 x 30 cm

Ceramic Tiles tops



50 x 50 cm Ø 50 cm 60 x 30 cm 60 x 45 cm

MATERIALS & FINISHES

Mirror finish 18/10 st. st.

Mirror finish 18/10 st. st.

MATERIALS & FINISHES

Transparent hardened glass
Smoked hardened glass

Arctic Wood Brown Shell Lava Stone
Light Brown Calacatta Noir Absolu
Walnut Travertine
Colonial Magma

Rust Calacatta Pure White
Black Lava Sand
Marquinia Black

la tavola®

Buffet Essentials

Must-have, designer accessories for an exceptional buffet service.





Display Trays



LOW
L 60 W 40 H 2,4 cm



LOW WITH COVER
L 60 W 40 H 12,3 cm



HIGH
L 60 W 40 H 13,3 cm



HIGH WITH COVER
L 60 W 40 H 23,3 cm

ST. ST. FINISHES

- Mirror finish 18/10 st. st.
- Satin finish 18/10 st. st.

TITANIUM FINISHES

- Black titanium
- Venetian gold titanium

- Gold titanium
- Platinum champagne titanium

SURFACE FINISH

- New Ice finish 18/10 st. st.



With a variety of frames, titanium color finishes and textured metal surfaces, the Display Trays are multifunctional and ideal for stylish and versatile food presentation.

Available in two heights, with or without transparent PETG cover. Simple, innovative designs that create a perfectly co-ordinated new collection.

Display trays are ideal for use with the Warming or Cooling Tray Systems.

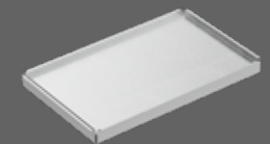

WARMING/COOLING TRAY
1/1 GN

High&Low Porcelain displays

SMALL ROUND BOWLS DISPLAYS



Ø 22,7 H 21 cm

Ø 22,7 H 29 cm

Ø 22,7 H 34 cm

PORCELAIN BOWLS AVAILABLE



Ø 25 H 6,5 cm It 1,7



Ø 25 H 9,5 cm It 2,3

LARGE ROUND BOWLS DISPLAYS



Ø 28,7 H 22 cm

Ø 28,7 H 30 cm

Ø 28,7 H 35 cm

PORCELAIN BOWLS AVAILABLE



Ø 31,5 H 6,5 cm It 2,6



Ø 31,5 H 12,5 cm It 5

ST. ST. FINISHES

- Mirror finish 18/10 st. st.

PORCELAIN BOWLS

Available in 4 colors



CHALK



GREY



GREEN



BLACK





Multipurpose and presentation trays



LOW EDGE TRAY
with black glass

L 50 W 30 H 4,2 cm
L 58 W 50 H 4,2 cm
L 65 W 37 H 4,2 cm
L 80 W 44 H 4,2 cm



MULTIPURPOSE TRAY

L 38 W 38 H 4,2 cm
L 58 W 58 H 4,2 cm
L 46 W 35 H 4,2 cm
L 50 W 38 H 4,2 cm
L 56 W 44 H 4,2 cm
L 65 W 45 H 4,2 cm
L 80 W 52 H 4,2 cm



PRESENTATION TRAY
with black glass

L 50 W 38 H 4,2 cm
L 65 W 45 H 4,2 cm
L 80 W 52 H 4,2 cm
L 58 W 58 H 4,2 cm



ST. ST. FINISHES

● Mirror finish 18/10 st. st.

The low-edged trays sit perfectly atop both the High & Low Risers



Wine coolers



INDIVIDUAL ICE BUCKET
Ø 14 H 13,5



ICE BUCKET
Ø 19,5 H 17



WINE COOLER 2 BOTTLES
Ø 24 H 22



Satin



Black



Bronze



STAND
for Wine cooler 2 bottles
H 60

ST. ST. FINISHES

● Mirror finish 18/10 st. st.

● Satin finish 18/10 st. st.

● Silverplated mirror finish

● Silverplated satin finish

● Black coated*

● Bronze coated*

● Dark black

*Only for Wine Cooler 2 bottles

CEREAL AND BEVERAGE
Jug-holders



RAINBOW
L 63 W 24 H 12,5 cm



Polycarbonate
CEREAL JUG
Ø 15 H 31 cm | cap. 3 lt.



Polycarbonate
JUICE JUG
with insert for ice
Ø 15 H 31 cm | cap. 3 lt.

ST. ST. FINISHES

- Mirror finish 18/10 st. st.
- Satin finish 18/10 st. st.

TITANIUM FINISHES

- Black titanium
- Venetian gold titanium
- Gold titanium
- Platinum champagne titanium

JUICE AND MILK
Dispensers



Methacrylate
JUICE DISPENSER*
L 33 W 18 H 57,7 cm
cap. 6 lt



CHILLED MILK DISPENSER
L 33 W 18 H 49 cm
cap. 6 lt

ST. ST. FINISHES

- Mirror finish 18/10 st. st.

*TITANIUM FINISHES
Only for juice dispenser

- Black titanium
- Venetian gold titanium
- Gold titanium
- Platinum champagne titanium

HPL FINISHES

- Arctic Wood
- Light Brown
- Walnut
- Colonial
- Brown Shell
- Calacatta
- Travertine
- Magma
- Lava Stone
- Noir Absolu

HOT BEVERAGES AND CEREALS
Dispensers



INSULATED BEVERAGE DISPENSER
L 42 W 27 H 46 cm
cap. 6 lt
⚡ 165 W



CEREALS DISPENSER
L 17 W 17 H 55,7 cm
cap. 3,5 lt

ST. ST. FINISHES

- Mirror finish 18/10 st. st.

JUICE AND CHILLED MILK DISPENSERS

- » Food safe anti-drip faucet
- » Crushed ice chilling insert
- » BPA free co-polyester liquid container (for juice)
- » Mirror polished 18/10 st. st. liquid container for fresh milk

CEREAL DISPENSER

- » Black wooden stand
- » Food safe portion distributor
- » BPA free co-polyester cereal container

INSULATED HOT BEVERAGE DISPENSER

- » Only 3°C temperature loss per hour
- » Food safe anti-drip faucet
- » 220V electric heating available (not for hot milk and hot chocolate)





CLOUD STAND

W 53,5 H 61 cm
Available only in satin finish

HPL FINISHES

- | | |
|---------------|---------------|
| ● Arctic Wood | ● Calacatta |
| ● Light Brown | ● Travertine |
| ● Walnut | ● Magma |
| ● Colonial | ● Lava Stone |
| ● Brown Shell | ● Noir Absolu |



REVOLVING MULTI-TIERS STAND

with st. st. cake stand platter or
glass bowls with or without methacrylic cover
H 66 cm

ST. ST. FINISHES

- Mirror finish 18/10 st. st.
- Satin finish 18/10 st. st.

TITANIUM FINISHES

- Black titanium
- Venetian gold titanium
- Gold titanium
- Platinum champagne titanium



BREAD CUTTING BOARD

with st. st tray
L 53 W 32,5 H 3 cm



Polyethylene CUTTING BOARD

L 60 W 40 cm
L 50 W 30 cm*
L 40 W 30 cm*

Bread tray and Cutting Boards*
(50x30 and 40x30 cm) are
available with **Display Trays**



FOOTED CAKE PLATE

Ø 31 H 5,5 cm

ST. ST. FINISHES

- Mirror finish 18/10 st. st.

TITANIUM FINISHES

- Black titanium
- Venetian gold titanium
- Gold titanium
- Platinum champagne titanium



SLOPING DISPLAY

L 50 W 25 H 16 cm



LACE BASKET

L 42 W 42 H 15 cm
L 28 W 28 H 11,5 cm
L 21 W 21 H 6 cm



CHECKERS BASKET

L 42 W 42 H 15 cm
L 28 W 28 H 11,5 cm
L 21 W 21 H 6 cm

ST. ST. FINISHES

- Mirror finish 18/10 st. st.
- Satin finish 18/10 st. st.

TITANIUM FINISHES

- Black titanium
- Venetian gold titanium
- Gold titanium
- Platinum champagne titanium



Health Shield

- » High grade PETG
- » HPL support and way-through to deliver hand dishes over to customers
- » Stainless steel heat protection for chef side (in case of proximity to livecooking)
- » Efficient storage
- » Premium design & feel
- » Easy break-down - all parts fit together seamlessly together stores in bag



Storage bag for Health Shield

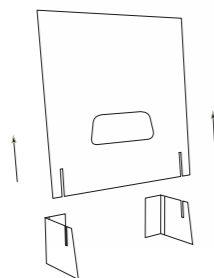

Easy to assemble



HEALTH SHIELD
L 80 W 25 H 87 cm

HPL FINISHES

- Arctic Wood
- Light Brown
- Walnut
- Colonial
- Brown Shell
- Calacatta
- Travertine
- Magma
- Lava Stone
- Noir Absolu

Sneeze Guard

- » PETG transparent panel
- » White LED light (optional)

ST. ST. FINISHES

- Satin finish 18/10 st. st.



SMALL SNEEZE GUARD
L 60 W 60 H 50 cm



MEDIUM SNEEZE GUARD
L 90 W 60 H 50 cm



STANDARD SNEEZE GUARD
L 120 W 60 H 50 cm



LARGE SNEEZE GUARD
L 180 W 60 H 50 cm

Action Stations

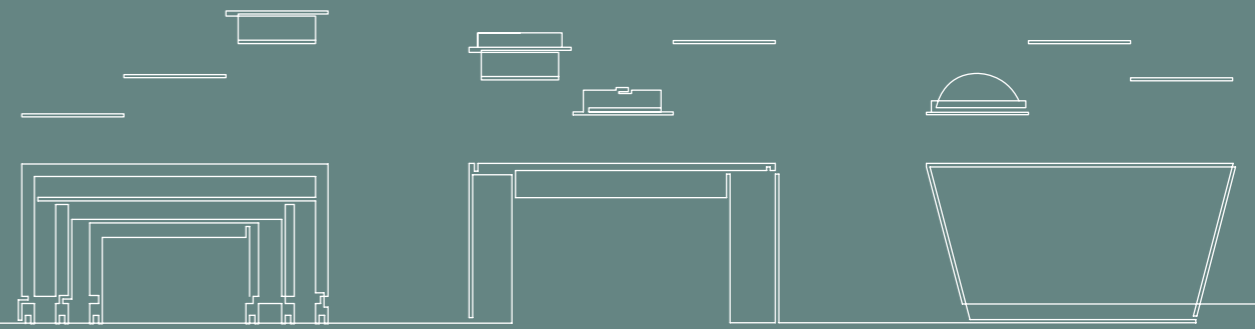

Create a dynamic banqueting experience thanks to La Tavola's crafty designs.

An extensive range of action stations purpose-built to fit even the most challenging banqueting demands: with patented Built-in Modular System, you will be able to switch between any cooking, cooling or warming function with no hassle. Simply remove the top and insert the function according to your service needs.

With more than 10 finishes available for customization to can match your existing interior décor, the action stations by La Tavola are crafted in premium stainless steel and HPL (High Pressure Laminate) for maximum efficiency and durability. Refined Italian designs created to perform under heavy duty usage without compromising on elegance, these action stations are a chef's dream when it comes to efficiently show-cooking in style.

LA TAVOLA OFFERS 7 MODELS OF ACTION STATIONS
AND MANY MODULES FOR WARM & COLD-HOLDING,
COOKING, BEVERAGE AND MIXOLOGY

FUNCTIONAL MODULES



Elemento
2 versions available



Nesting Table
3 sizes and 2 versions available



Magic Cart
2 sizes and 2 versions available



The Grand
2 versions available



The Bridge
2 sizes and 2 versions available



Catering Table
2 versions available



Magic Table
3 sizes available

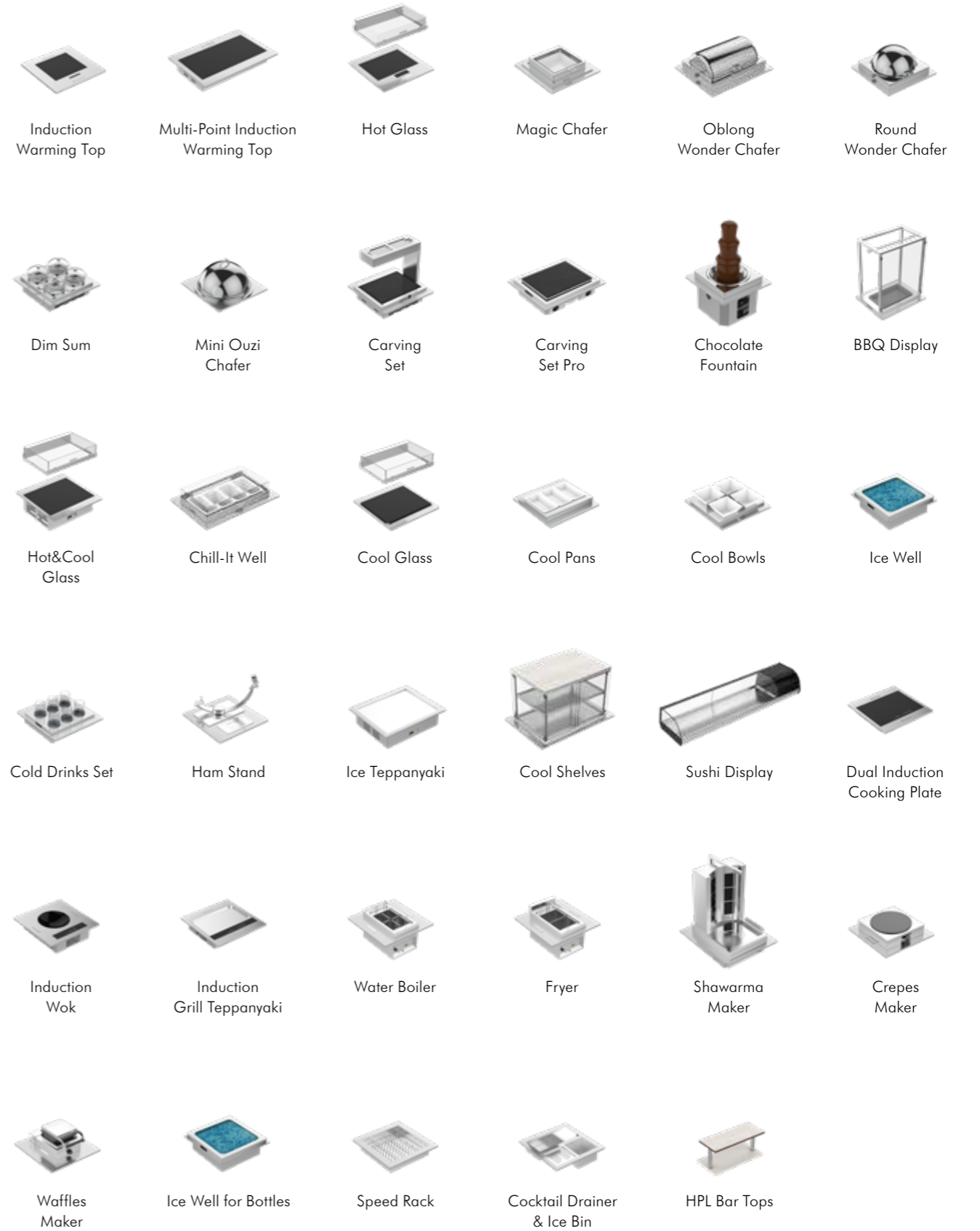



Elemento

The beauty of simplicity

- » Stainless steel 18/10 structure, brushed finish, powder coated colors, black, gold or copper/bronze
- » Superior strength and resistance to wear and tear
- » Wiring management system
- » Breaks down with ease, no tools needed
- » Assembly / disassembly requires minimal time, 2 minutes on average
- » Detachable skirtings available in matching finishes
- » Dynamic Built-In Modular System
- » Stores in custom made, extra strong Cordura bags



FOLDABLE EXTENSIONS WITH MIDDLE SHELF

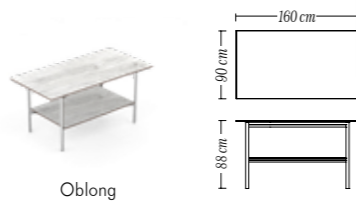
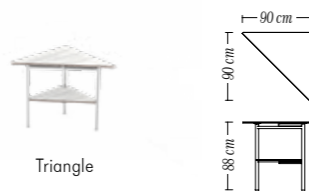
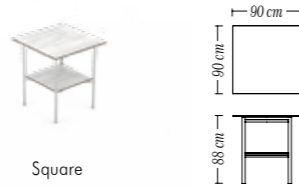

FRAME AND LEGS FINISHES AVAILABLE

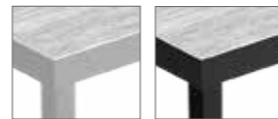

Stainless steel brushed finish



Powder coating Black

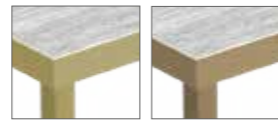

Powder coating Gold



Powder coating Copper/Bronze

Cart and Bag kit for Elemento Table

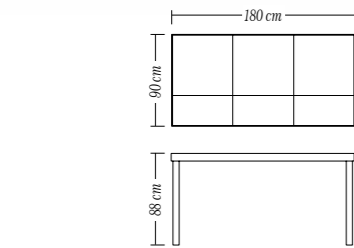

STRUCTURE FINISHES

- HPL FINISHES AVAILABLE
- Arctic Wood
 - Walnut
 - Brown Shell
 - Travertine
 - Lava Stone
 - Light Brown
 - Colonial
 - Calacatta
 - Magma
 - Noir Absolu

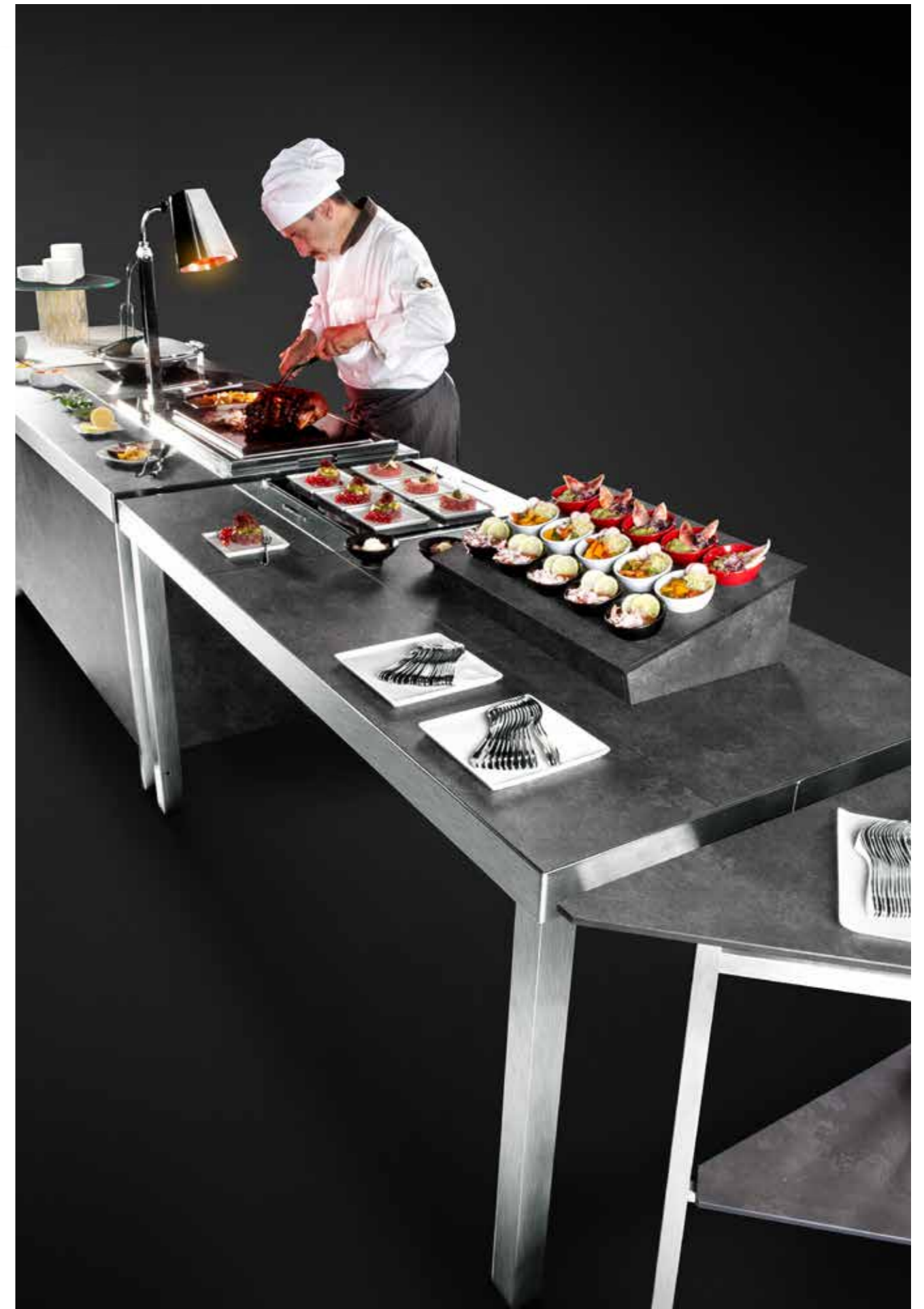

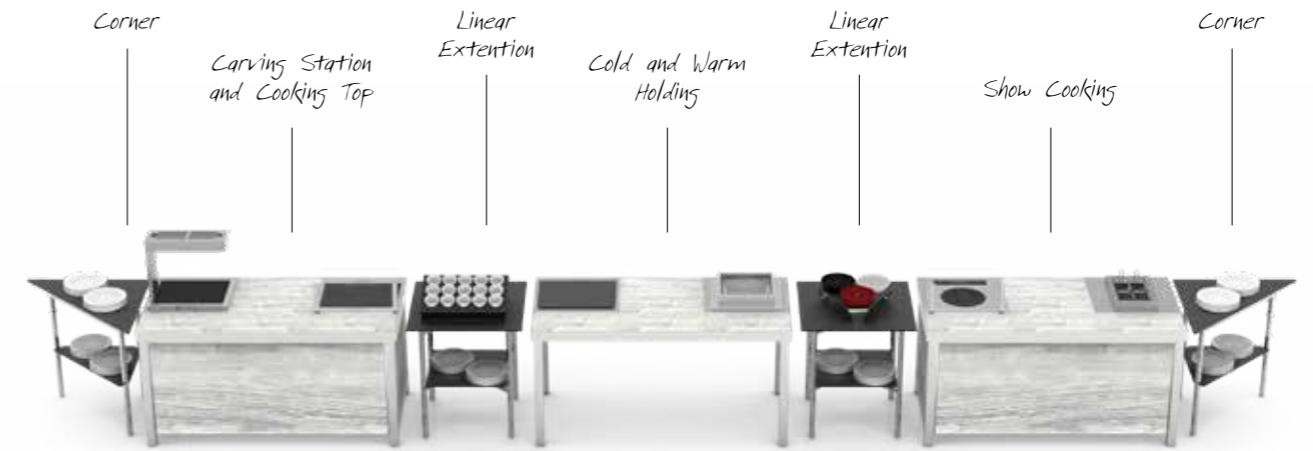

Use its specific Skates to move Elemento easily





Nesting Table

Design meets mobility meets storage value

- » Stainless steel 18/10 structure, deep matt finish
- » Nesting storage value: 3 pieces in the space of one
- » Superior strength and resistance to wear and tear
- » Wiring management system
- » Heavy duty casters with brakes
- » Dynamic Built-In Modular System



Small
NESTING TABLE
with or without skirting

Medium
NESTING TABLE
with or without skirting

Large
NESTING TABLE
with or without skirting

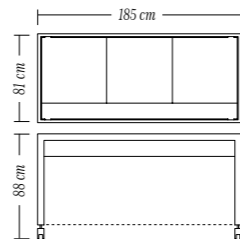
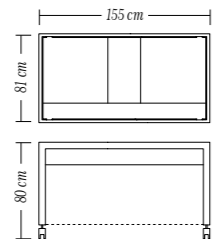
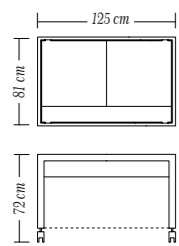

NESTING TABLE
EXTENSION

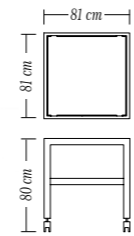

Two extensions can fit
underneath one Large
Nesting table

HPL FINISHES
AVAILABLE

- | | | | | |
|-------------|----------|-------------|------------|-------------|
| Arctic Wood | Walnut | Brown Shell | Travertine | Lava Stone |
| Light Brown | Colonial | Calacatta | Magma | Noir Absolu |

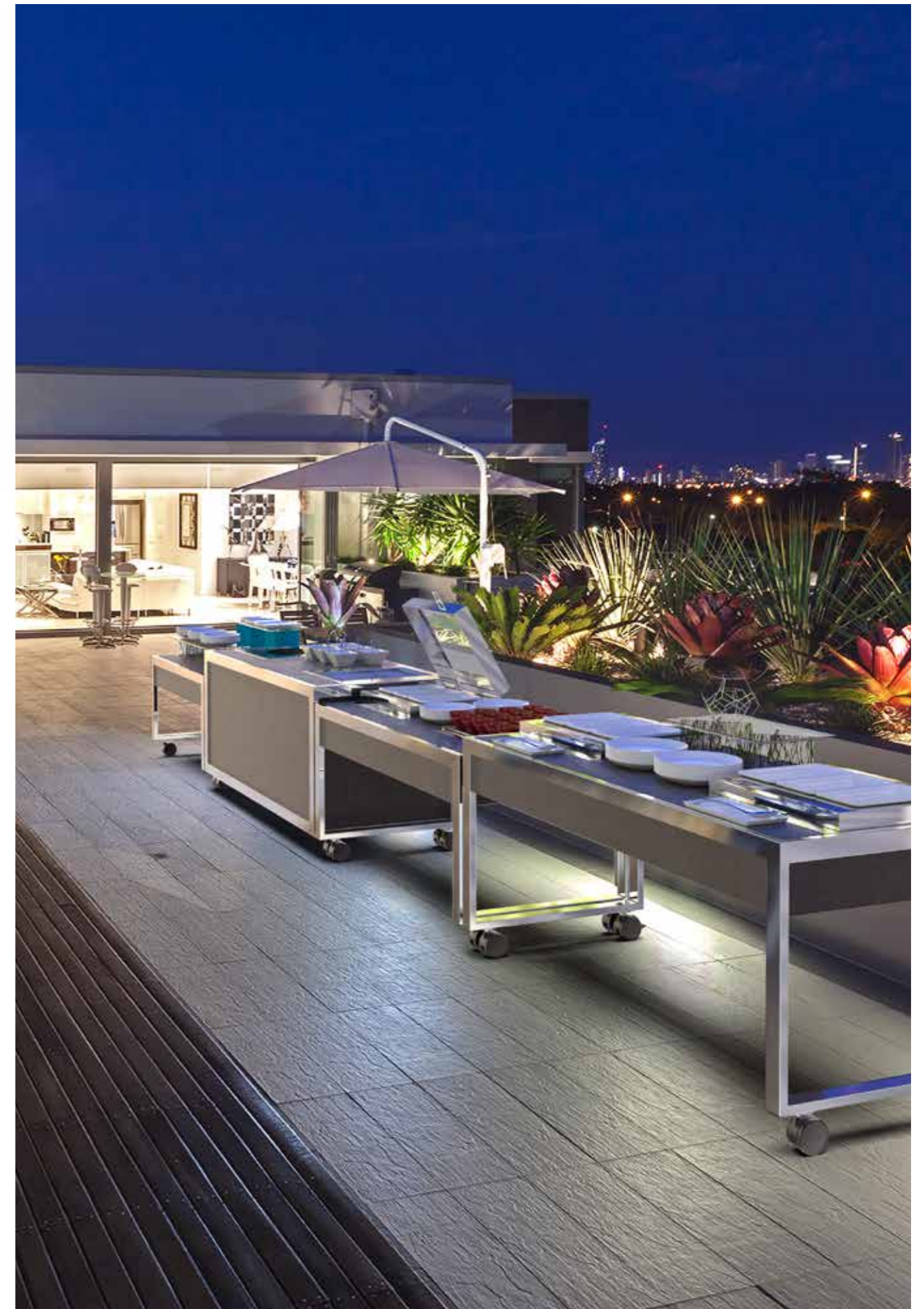





Magic Cart

A new frontier in mobile food service

- » Stainless steel 18/10 structure, deep matt finish and powder coated colors
- » Superior strength and resistance to wear and tear
- » Wiring management system
- » Heavy duty casters with brakes
- » Dynamic Built-In Modular System



Large storage space



LITE
MAGIC CART
Large



LITE
MAGIC CART
Small



MAGIC CART
Large



MAGIC CART
Small

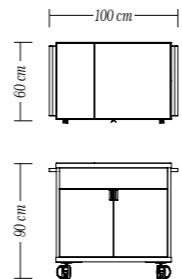
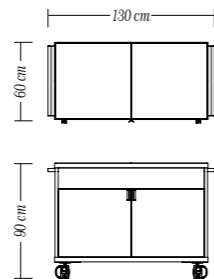
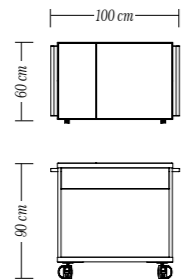
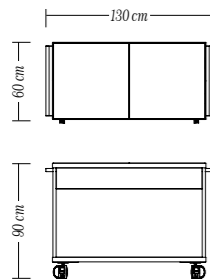

STRUCTURE FINISHES

- HPL FINISHES AVAILABLE
- Arctic Wood
 - Walnut
 - Brown Shell
 - Travertine
 - Lava Stone
 - Light Brown
 - Colonial
 - Calacatta
 - Magma
 - Noir Absolu



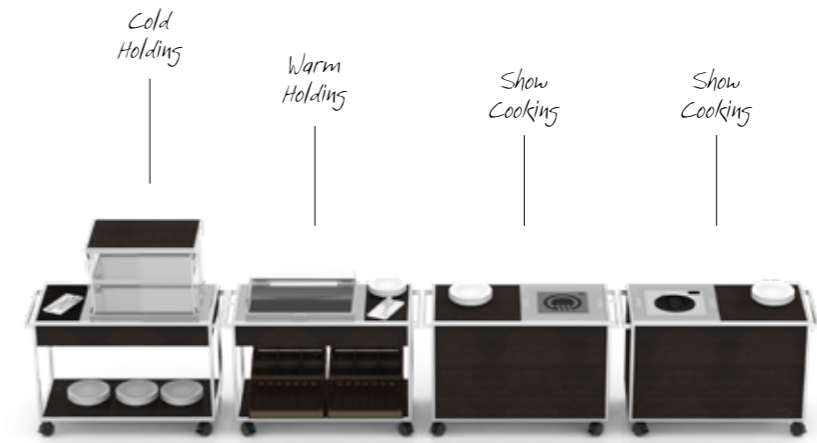



The Grand

An architectural masterpiece

- » Stainless steel 18/10 structure, brushed finish, powder coated colors, black, gold or copper/bronze
- » Minimally intrusive Edge Protection System
- » Superior strength and resistance to wear and tear



- » Wiring management system
- » Heavy duty casters with brakes
- » Large inner storage area
- » Dynamic Built-In Modular System

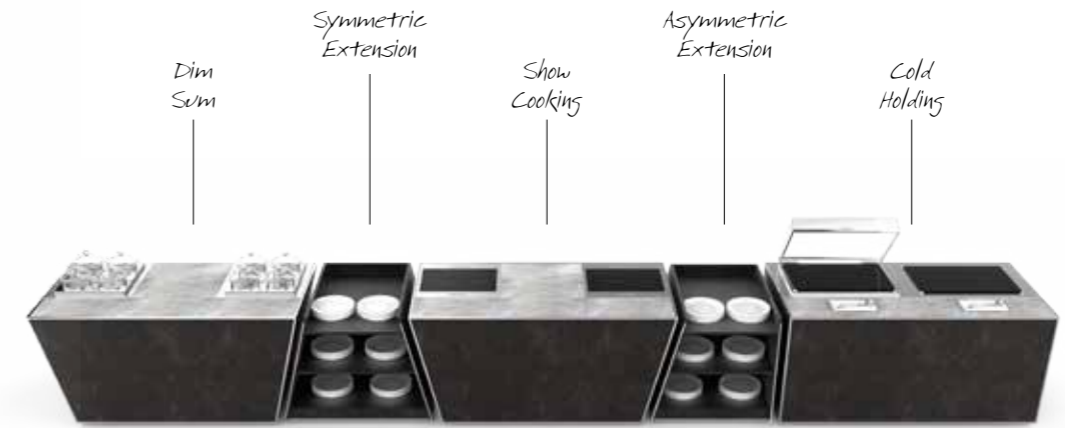

THE GRAND
Conical

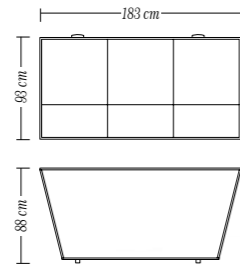

THE GRAND
Linear

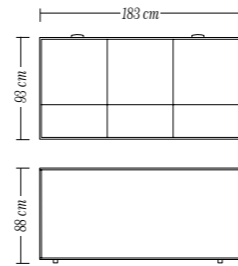

LINEAR
Extension

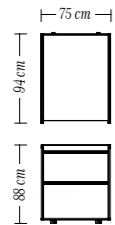

ASYMMETRIC
Extension

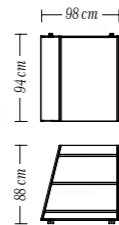

*left and right side



SYMMETRIC
Extension

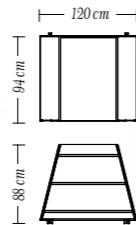

CORNER
Extension

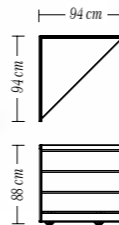

EDGES FINISHES AVAILABLE



Stainless steel brushed finish



Powder coating Black



Powder coating Gold



Powder coating Copper/Bronze

HPL FINISHES AVAILABLE

Arctic Wood

Walnut

Brown Shell

Travertine

Lava Stone

Light Brown

Colonial

Calacatta

Magma

Noir Absolu





The Bridge

Ultimate luxury in a buffet setting

- » Stainless steel 18/10 structure, deep matt finish
- » Superior strength and resistance to wear and tear
- » Wiring management system



- » Heavy Duty casters with brakes
- » Dynamic Built-In Modular System
- » Richly customizable design



THE BRIDGE
Small



THE BRIDGE
Small w/skirting

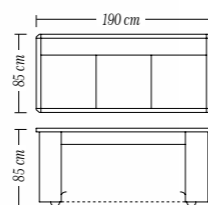

HIDDEN WHEELS
Good to have them,
even better not to see
them



THE BRIDGE
Large



THE BRIDGE
Large w/skirting

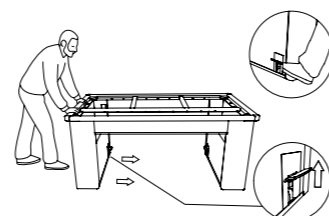
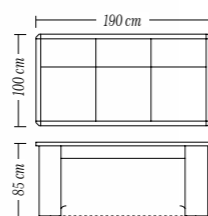

BRAKING SYSTEM
Accessible at all times

- HPL FINISHES AVAILABLE
- | | | | | |
|---------------|------------|---------------|--------------|---------------|
| ● Arctic Wood | ● Walnut | ● Brown Shell | ● Travertine | ● Lava Stone |
| ● Light Brown | ● Colonial | ● Calacatta | ● Magma | ● Noir Absolu |





Catering Table

Never cease to amaze your guests

- » Stainless steel 18/10 structure, deep matt finish
- » Superior strength and resistance to wear and tear
- » Wiring management system
- » Breaks down into 5 pieces, no tools needed
- » On wheels with brakes
- » Built-In plate holder
- » Disassembly / assembly requires minimal time, on average 2 minutes
- » Dynamic Built-In Modular System
- » Stores in custom made, extra strong Cordura bags



CATERING TABLE

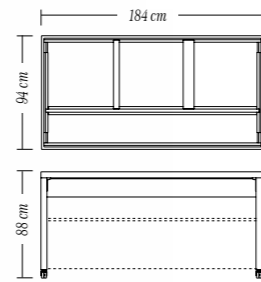
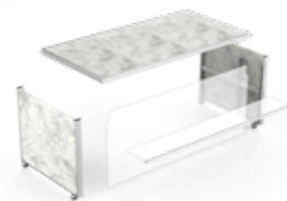

PLATE-HOLDER

The Catering Table can be assembled with or without plate-holder by simply inserting the front panel in the central or frontal position



Cart and Bag kit for Catering Tables



LITE CATERING TABLE

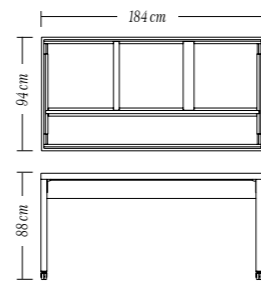

HPL FINISHES AVAILABLE

- | | | | | |
|---------------|------------|---------------|--------------|---------------|
| ● Arctic Wood | ● Walnut | ● Brown Shell | ● Travertine | ● Lava Stone |
| ● Light Brown | ● Colonial | ● Calacatta | ● Magma | ● Noir Absolu |





Magic Table

The one and only

- » Stainless steel 18/10 structure, deep matt finish
- » Superior strength and resistance to wear and tear
- » Wiring management system
- » Breaks down into 5 pieces, no tools needed
- » Disassembly / assembly requires minimal time, on average 2 minutes
- » Dynamic Built-In Modular System
- » Stores in custom made, extra strong cordura bags



MAGIC TABLE
Large

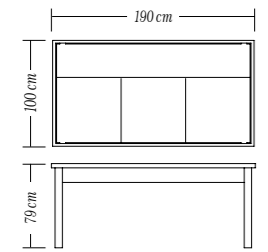

MAGIC TABLE
Medium

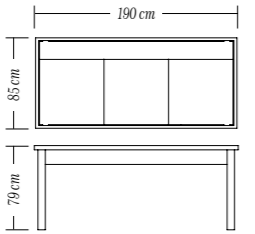

MAGIC TABLE
Small

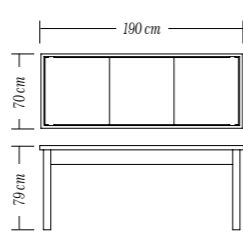

Cart and Bag kit
for Magic Table



LEGS AND CORNERS
ALSO AVAILABLE IN
TITANIUM FINISH

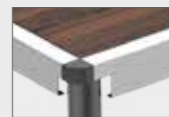

Black



Gold



Venetian Gold



Platinum Champagne

HPL FINISHES
AVAILABLE

- | | | | | |
|---------------|------------|---------------|--------------|---------------|
| ● Arctic Wood | ● Walnut | ● Brown Shell | ● Travertine | ● Lava Stone |
| ● Light Brown | ● Colonial | ● Calacatta | ● Magma | ● Noir Absolu |



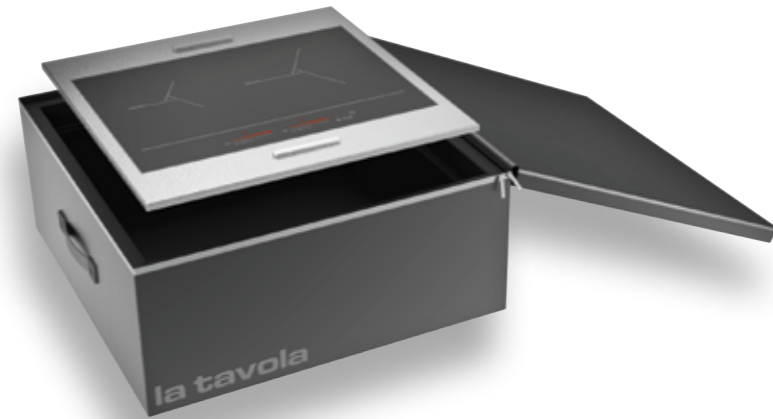

Functional Modules

WITH WARMING, COOLING, COOKING AND MIXOLOGY MODULES AVAILABLE, THE DYNAMIC BUILT-IN MODULAR SYSTEM® GIVES LA TAVOLA'S BUFFET STATIONS TOTAL VERSATILITY

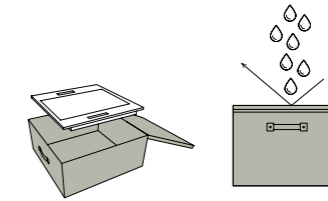

EACH MODULES COMES WITH A DURABLE CUSTOM-MADE CASE FOR STORAGE AND TRANSPORTATION. WATERPROOF, EASY TO CLEAN, HYGIENIC.

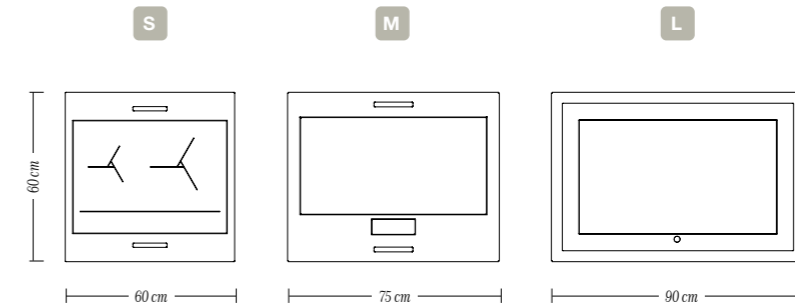

MODULES COMES IN 3 SIZES (SMALL, MEDIUM AND LARGE)

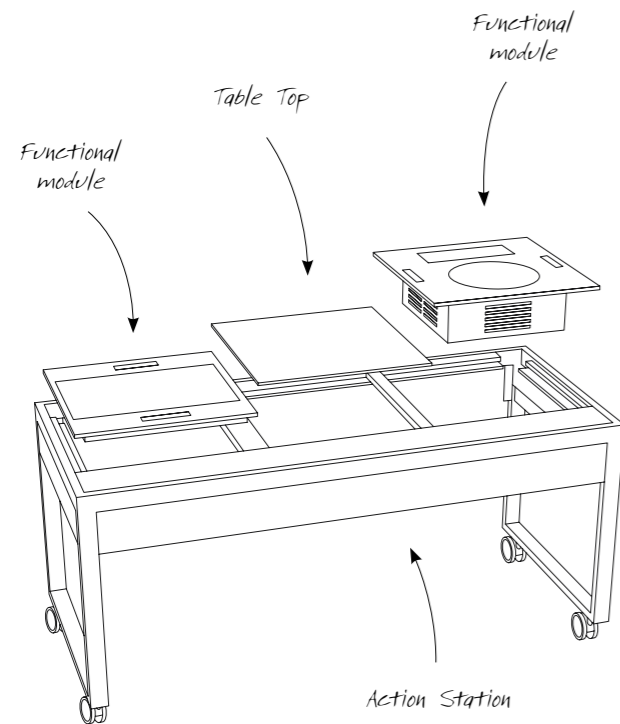

At the heart of the Modular Line is our Dynamic Built-In Modular System (DBMS), technology patented by La Tavola®.

The DBMS is a very clever yet simple mobile frame that allows you to incorporate any of La Tavola's functional modules for warming, cooling, cooking and ambient temperature display into any one of our tables.

This is how we have created a system that knows no boundaries.

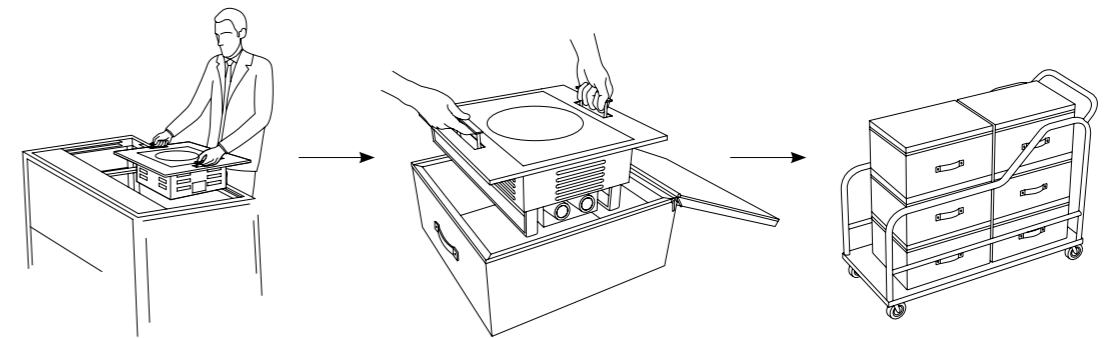

EASY USAGE, TRANSPORTATION AND STORAGE



Cart for transportation, modules' storage and freestanding functions

Warm Holding MODULES



INDUCTION WARMING TOP

S 60 x 60 cm

- » Automatic pan detection, instant energy transmission
- » Highly energy efficient
- » Glass-ceramic surface top
- » 70 > 120 °C temperature range
- » Link chain system
- » ⚡ 350 W or ⚡ 700 W

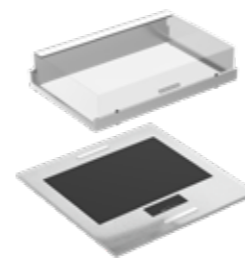

HOT GLASS

S 60 x 60 cm **M** 75 x 60 cm

- » Uniform temperature distribution
- » Easy access to temperature regulators
- » Link chain system
- » Removable cover (optional)
- » ⚡ 675 W (S size) ⚡ 900 W (M size)
- » **1/1 GN** **1/1+1/3 GN**



MAGIC CHAFER

S 60 x 60 cm

- » Patented Humidity Control System
- » Condensation recovery system
- » Stainless steel 18/10 cover and mechanical hinges
- » Cast aluminium water pan with 5 compartments
- » ⚡ 700 W
- » **2/3 GN**



OBLONG WONDER CHAFER

M 75 x 60 cm

- » Opens to 170°
- » Steam collection rim around cover for condensation recovery
- » Porcelain and stainless steel food pans available
- » ⚡ 700 W
- » **1/1 GN**



MULTI-POINT INDUCTION WARMING TOP

L 90 x 60 cm

- » Digital temperature display
- » "No pan no heat" technology for minimal energy wastage
- » Suitable for use with up to 4 induction-ready containers
- » 60 > 100 °C
- » ⚡ 1500 W

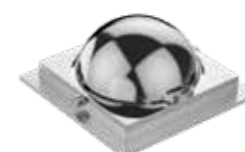

ROUND WONDER CHAFER

S 60 x 60 cm

- » Opens to 170°
- » Steam collection rim around cover for condensation recovery
- » Porcelain and stainless steel food pans available
- » ⚡ 500 W



DIM SUM

S 60 x 60 cm

- » 4 Separate areas for stackable baskets
- » Can also be used with traditional bamboo baskets
- » Premium glass see-through baskets
- » Liquid recovery system
- » ⚡ 2x 700 W



MINI OUZI CHAFER

S 60 x 60 cm

- » Removable cover
- » Handle on cover available in different colors
- » Stainless steel food pan 50 cm
- » ⚡ 2x 700 W



CARVING SET

S 60 x 60 cm

- » Premium granite base, removable for easy cleaning
- » Heating lamp with infrared strips
- » ⚡ 500 W (lamp)
- » ⚡ 2x 700 W (carving)

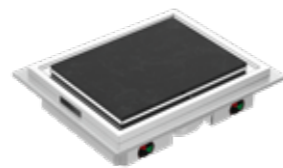

CARVING SET PRO

M 75 x 60 cm

- » Removable black granite top
- » Excess liquid collection system with recovery tank
- » Uniform temperature distribution
- » Easy access to temperature regulators
- » Temperature (granite): 80 °C
- » ⚡ 2x 700 W



CHOCOLATE FOUNTAIN

S 60 x 60 cm

- » Stainless steel 18/10 body and parts
- » Detachable basin
- » Available in two different size: H 43 or H 84 cm
- » Electronic touch controller
- » Easy cleaning and maintenance
- » ⚡ 500 W



BBQ DISPLAY

M 75 x 60 cm

- » Stainless steel 18/10 structure
- » Sneeze guard
- » Pan for liquid recovery
- » Optional: Heating lamp ⚡ 500 W

ACCESSORY FOR WARM HOLDING



HEAT LAMPS

- » Ideal for Carving Set Pro module
- » W 27 L 20 H 70 cm
- » Available with 1 or 2 heating lamps
- » Ideal for carving or warming top unit
- » Stainless steel structure, mirror finish
- » Excellent stability
- » ⚡ 1x 250 W / 2x 250 W



INFRARED HEAT LAMP

- » L 60 W 40 H 40 cm
- » Stainless steel structure, satin finish
- » Excellent stability
- » ⚡ 470 W



**Warm&Cold Holding
MODULE**



HOT&COOL GLASS

S 60 x 60 cm **L** 90 x 60 cm

- » -5 °C > +90 °C temperature range
- » Digital temperature control and feedback
- » Removable cover (optional)
- » ⚡ 850 W
- » **1/1 GN** **1/1+1/3 GN**

Cold Holding MODULES



CHILL-IT WELL

L 90 x 60 cm

- » Transparent PETG cover reinforced with stainless steel frame
- » Eutectic cooling technology - no ice or electricity required
- » Eutectic plate releases cold for up to 4 hours
- » Stockable, double walled Chill-It pans containing food safe gel
- » **1/1+1/3 GN**

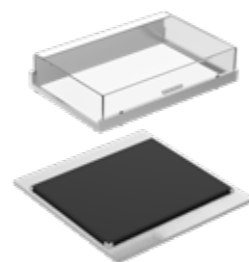

COOL BOWLS

S 60 x 60 cm

- » Eutectic cooling technology - no ice or electricity required
- » Eutectic plate releases cold for up to 5 hours
- » Stainless steel 18/10 structure
- » Ceramic bowls available in black or white



ICE WELL

S 60 x 60 cm **L** 90 x 60 cm

- » Condensation recovery system
- » Drainage system with faucet



COLD DRINK SET

S 60 x 60 cm

- » Eutectic cooling technology - no ice or electricity required
- » Eutectic cylinders release cold for up to 4 hours
- » Stainless steel 18/10 structure
- » Available with 6 glass jugs with beak and plastic cover

COOL GLASS

S 60 x 60 cm **L** 90 x 60 cm

- » Eutectic cooling technology - no ice or electricity required
- » Eutectic plate releases cold for up to 5 hours
- » Removable tempered glass top, black finish
- » Removable cover (optional)



HAM STAND

S 60 x 60 cm

- » Tilting ham holder
- » 360° rotation
- » 45° inclination
- » Knife holder
- » 1/3 GN food pan with cover included



ICE TEPPANYAKI

M 75 x 60 cm

- » Lowest temperature: -30 °C
- » Simple control and digital temperature feedback
- » Temperature settings: 28
- » **⚡** 70 W



COOL SHELVES

L 90 x 60 cm

- » 2 high performance eutectic units
- » Cold maintained for up to 5 hours. Even surface temperature (1 °C to 4 °C)
- » Transparent sliding doors
- » Structure available with glass or polycarbonate sides



COOL PANS

S 60 x 60 cm **L** 90 x 60 cm

- » Eutectic cooling technology - no ice or electricity required
- » Eutectic plate releases cold for up to 5 hours
- » Wide range of ceramic GN food pans available
- » **1/1 GN** **1/1+1/3 GN**



SUSHI DISPLAY

145 x 39 x 24 cm | 110 x 39 x 24 cm

- » Stainless steel inner tray
- » Integrated digital thermostat with remote control panel
- » Automatic defrosting every 6 hours or at selected interval
- » +4 °C > +8 °C temperature range
- » **⚡** 130 W

Professional Cooking MODULES



DUAL INDUCTION COOKING PLATE

S 60 x 60 cm

- » Cooking areas:
Ø 145 ⚡ 1400 W / 1100 W
Ø 210 ⚡ 2300 W / 1600 W
- » All power (⚡ 3700 W / 2700 W)
can be directed on one large pan
- » Automatic safety switch-off function
- » Booster function for quick heating
- » Timer function



INDUCTION GRILL TEPPANYAKI

S 60 x 60 cm

- » Cooking area: L 30 W 47 cm
⚡ 3700 W (1400 W + 2300 W)
⚡ 2700 W (1100 W + 1600 W)
- » Booster function for quick heating
- » Timer function



WATER BOILER

S 60 x 60 cm

- » 10 liters capacity
- » Easy to clean. Easy-to-use tap for draining
after use
- » Maximum of four 14 x 10 x 13,5 cm cooking
baskets
- » 18/10 Stainless protective body
- » ⚡ 2830 W



FRYER

S 60 x 60 cm

- » 10 liters capacity
- » Easy to clean. Easy-to-use tap for draining
after use
- » Stainless steel 18/10 structure
- » Maximum of four 14 x 10 x 13.5 cm cooking
baskets
- » ⚡ 3000 W



INDUCTION WOK

S 60 x 60 cm

- » Cooking area: Ø 31 cm
⚡ 3700 W / 2700 W
- » Pan size: Ø 36 cm
- » Digital controls for regulation of temperature
and other settings
- » Automatic safety switch-off function
- » Booster function for quick heating
- » Timer function



SHAWARMA MAKER

M 60 x 75 cm

- » Electric heating with black sealed glass
protection
- » Easy access to temperature control
- » Liquid recovery system
- » Removable scrap pan
- » Easy cleaning and maintenance
- » ⚡ 4200 W



CREPES MAKER

S 60 x 60 cm

- » Easy access to temperature control
- » 30 °C > 300 °C temperature range
- » ⚡ 2500 W



WAFFLES MAKER

S 60 x 60 cm

- » Waffle size 18x10 cm - two at a time
- » 0 °C > 300 °C temperature range
- » ⚡ 1600 W

Beverage&Mixology MODULES



ICE WELL FOR BOTTLES

S 60 x 60 cm

- » Condensation recovery system
- » Drainage system with faucet

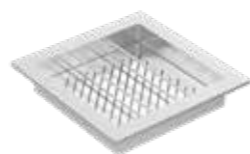

SPEED RACK

S 60 x 60 cm

- » Up to 12 bottles
- » Recovery liquid system



COCKTAIL DRAINER & ICE BIN

S 60 x 60 cm

- » Storage for tools
- » Cube ice bin
- » Crushed ice or trash bin
- » Cocktail drainer



HPL BAR TOPS

L 60 W 30 cm
L 90 W 30 cm

- » St. steel structure
- » HPL base and countertop surface

Accessories FOR FUNCTIONAL MODULES



SNEEZE GUARD FREESTANDING

L 60 W 60 H 50 cm
L 90 W 60 H 50 cm
L 120 W 60 H 50 cm
L 180 W 60 H 50 cm

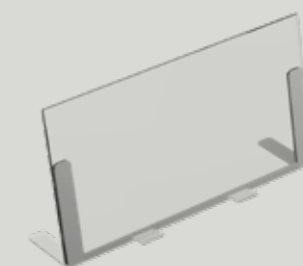

ANTI SPLASH GUARD FOR COOKING MODULES

L 60 W 15 H 30 cm



PLATE HEATER

- SMALL
 » L 60 W 51 H 87 cm
- LARGE
 » L 100 W 51 H 87 cm
 » Mobile plate holder - holds up to 120 plates
 » 30-90 °C temperature range
 » Casters with brakes
 » ⚡ 1200 W (single) 2400 W (double)



WORKING STATION WITH SINK

- L 130 W 60 H 90 cm
 » Portable sink and work surface
 » 25 lt capacity and independent recovery of liquids
 » Wireless (battery powered)
 » Casters with brakes

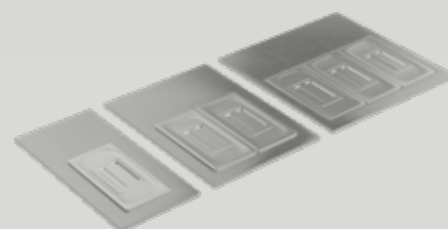

SERVICE TILES

- » Several different sizes available
 » Integrated GN food pans for sauces or scraps



MOBILE EXHAUST

- L 64 W 48 H 90 (closed) 120 (open)
 » 4 Power levels
 » 900 m³/h capacity
 » Touch Control
 » Casters with brakes
 » Customizable finishes
 » ⚡ 500 W

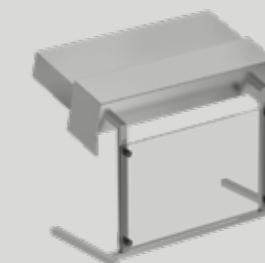

PORTABLE EXHAUST

- » L 59 W 34 H 55 cm
 » Stainless steel structure, satin finish
 » 144 m³/h capacity
 » Transparent hardened glass finish
 » 2 aspiration sections with active carbon filter, filters are easily replaceable
 » Integrated splash guard
 » High suction power
 » ⚡ 80 W



icona®

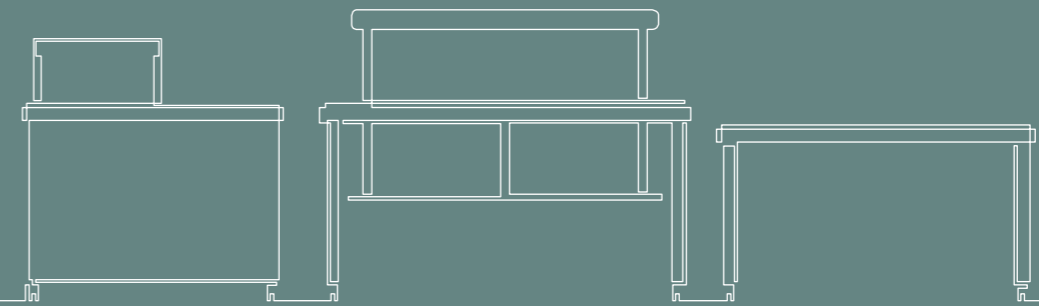

Icona is the latest line from La Tavola. It has been designed and made to meet the latest presentation trends as well as to provide unparalleled simplicity of use and maintenance.

All of this without ever sacrificing our commitment to pure design.

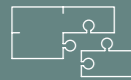

WARM/COLD HOLDING
+ SHOWCOOKING



PLUG
AND PLAY



MAXIMUM EASE
OF SET-UP
AND CLEAR-DOWN



FULLY
ACCESSORIZED



EFFICIENT
STORAGE

WE GOT YOU COVERED WITH **icona®**



Warm



ICONA FOR WARM HOLDING

Cool



ICONA FOR COLD HOLDING

Cook



ICONA FOR SHOW COOKING

NESTING STORAGE VALUE
3 PIECES IN THE SPACE OF 1

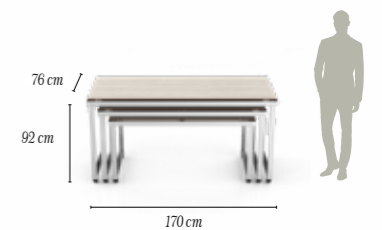

HPL FINISHES AVAILABLE

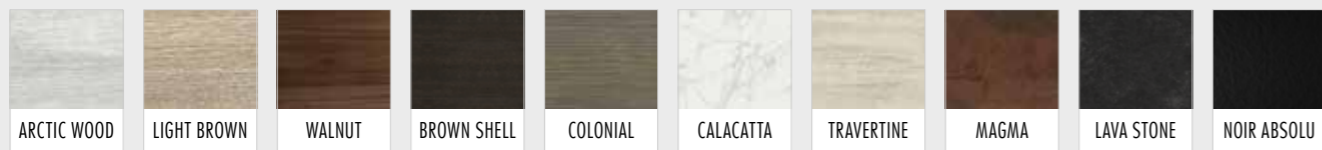

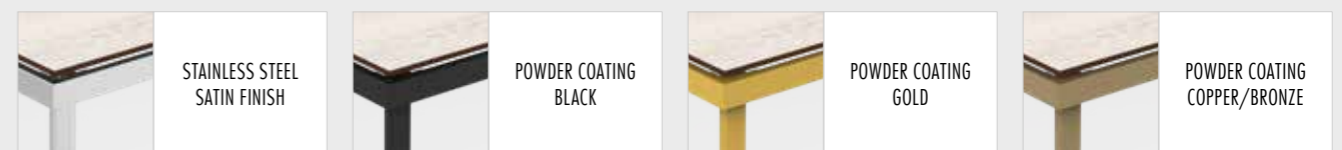

FRAME AND LEGS FINISHES AVAILABLE





icona®
For Warm Holding

STRUCTURE FINISHES  HPL FINISHES 

- » L 170 W 76 H 92 cm
- » St. st. 18/10 structure
- » Heavy duty casters, 2 with brakes

- » HPL tops and skirts
- » Removable heat bridge/sneeze guard (optional)
- » Removable skirts and plate-holder (optional)

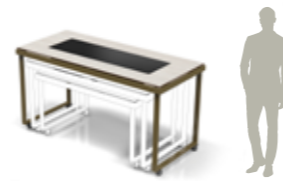

⚡ Electric version

- » Black Ceran® glass
- » 2x 900 W Independent warming areas
- » 2 Electric plugs for Heating Lamp

🔥 Secret induction version

- » 3x 350 W - 3x 700 W Induction units
- » Serial connection system (up to 3 units with 1 cable out-let)
- » Silicon Pad provided to protect the surface from heat

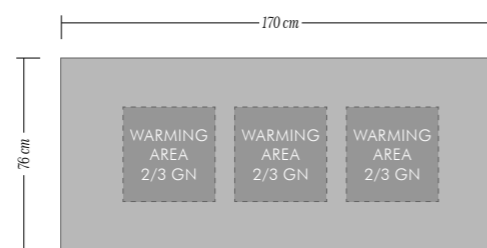
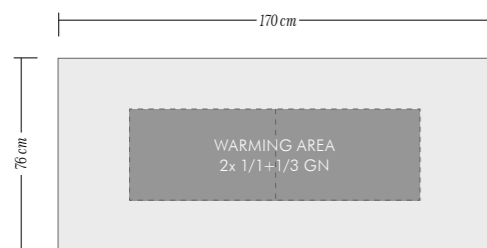



icona®
For Cold Holding

STRUCTURE FINISHES  HPL FINISHES 

- » L 145 W 76 H 84 cm
- » Heavy duty casters, 2 with brakes
- » St. st. 18/10 structure
- » HPL tops and skirts
- » Removable skirts and plate-holder (optional)

- » Heavy Duty tempered glass
- » Working Area Capacity 2x 1/1 GN
- » Powered by professional ice packs
- » Removable sneeze guard (optional)

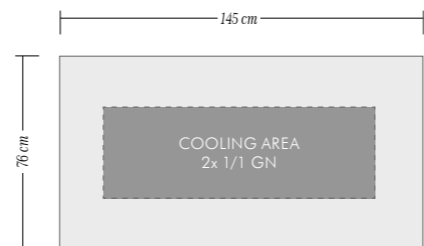
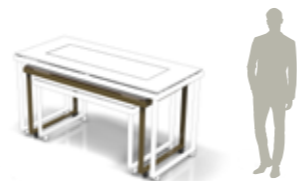



icona®
For Show Cooking

- » L 120 W 76 H from 76 to 92 cm
- » Available in 3 versions:
 - DUAL INDUCTION COOKING PLATE
 - INDUCTION WOK
 - INDUCTION GRILL TEPPANYAKI
- » Heavy duty casters, 2 with brakes
- » Stainless steel 18/10 structure

STRUCTURE FINISHES HPL FINISHES

- » HPL tops and skirts
- » Removable skirts and plate-holder (optional)
- » Anti-scratch working area around induction
- » Dual touch controls
- » Anti-splash guard (optional)

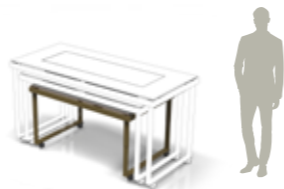

ADJUSTABLE LEGS
TO NEST THE TABLE



Add-Ons for icona®



Sneeze Guard

L 110 W 58 H 46 cm
L 140 W 58 H 46 cm
L 160 W 58 H 46 cm

- » Stainless steel finishes available in many colors
- » PETG transparent panel
- » Lights (optional)



3-Side Skirtings

- » For Warming, Cooling and Cooking tables
- » HPL panels
- » Hanging system on top
- » Magnetic locking system on bottom (4 magnets on each panel)
- » 6 mm thickness
- » Reinforced fixing point
- » Light weight panels
- » Bags for storage are available



Plate Holder

- » For Warming, Cooling and Cooking tables
- » St. st. hanging structure (3 pcs.)
- » HPL 11 mm surface
- » Stainless steel finishes available in many colors



Portable Exhaust

L 59 W 34 H 55 cm

- » Stainless steel structure, mirror and satin finish
- » Transparent hardened glass finish
- » 2 aspiration sections with active carbon filter Filters are easily replaceable
- » Integrated splash guard
- » High suction power
- » ⚡ 80 W

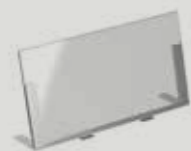

Anti Splash Guard

L 60 W 15 H 30 cm

- » For Warming and Cooling Tables
- » St. st. structure
- » PETG dual-side sneeze guard

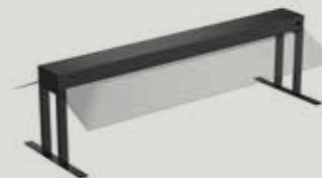

Heat Lamp

L 140 W 58 H 43 cm

- » Stainless steel structure, black powder coated finish
- » Easy to remove supporting structure
- » 2 lateral PETG sneeze guards
- » Infrared heating lamp
- » 1100 W



Mobile Banqueting Furniture



With the most innovative and complete Beverage & Mixology line on the market, La Tavola boasts a selection of fully-equipped and customizable mobile bars, cocktail tables and vertical displays that aim to foster your guests' overall satisfaction.

Discover a meticulously designed selection of carts that provides for the diverse needs of the hospitality world and a refined collection of Cocktail and Buffet tables, completely foldable and easy to store and move thanks to their dedicated storage carts.

All the furniture is crafted to perform under heavy-duty usage and aims to blend-in with your existing interior décor by allowing for a total customization of its finishes and materials.

la tavola®

Buffet tables





SMALL
LITE NESTING TABLE

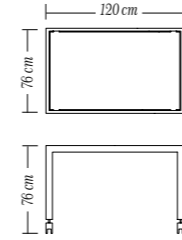

MEDIUM
LITE NESTING TABLE

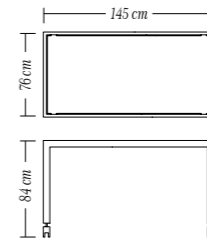

LARGE
LITE NESTING TABLE

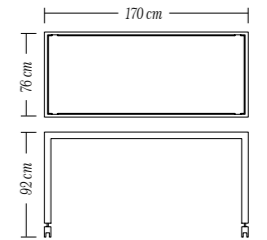

LITE NESTING TABLES ARE ALSO AVAILABLE WITH REMOVABLE SKIRTING AND PLATE HOLDER



Storage bags for
skirting and plate
holder

Lite Nesting Tables

STRUCTURE FINISHES ●●●● HPL FINISHES ●●●●●●●●●●●●●●●●●●●●

- » Stainless steel 18/10 structure, deep matt finish or powder coated finishes
- » Nesting Storage value: 3 pieces in the space of 1
- » Superior Strength and resistance to wear and tear
- » Heavy Duty casters with brakes

- » Detachable skirtings available in matching finishes
- » Detachable plate holder available
- » Available also with black and white glass top

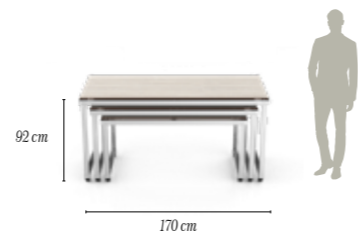

HPL FINISHES AVAILABLE



FRAME AND LEGS FINISHES AVAILABLE

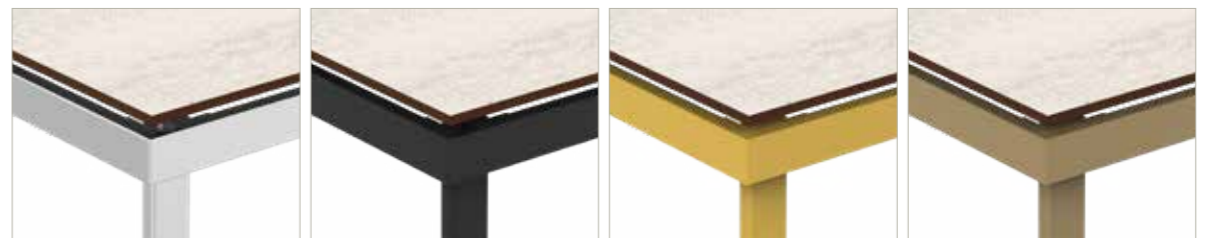

STAINLESS STEEL
SATIN FINISH

POWDER COATING
BLACK

POWDER COATING
GOLD

POWDER COATING
COPPER/BRONZE



LITE NESTING TABLES
Stunning design and colours, storage value & longevity



Match the structure finishes with the HPL finishes



BLACK ●
NOIR ABSOLU ●



GOLD ●
WALNUT ●



SATIN ●
ARCTIC WOOD ●



BRONZE ●
MAGMA ●



Lite Nesting Tables and La Tavola's Freestanding Buffetware

An explosive combination of Look & Functionality



Foldable Buffet Tables

- » Stainless steel 18/10 structure
- » Deep matt or powder coating finishes
- » Compact HPL tops, 10 finishes
- » Magnetic locking system
- » Uneven terrain adjustment system
- » Foldable, can be stored in its dedicated cart



Table Cart

STRUCTURE FINISHES ●●●●● HPL FINISHES ●●●●●●●●●●

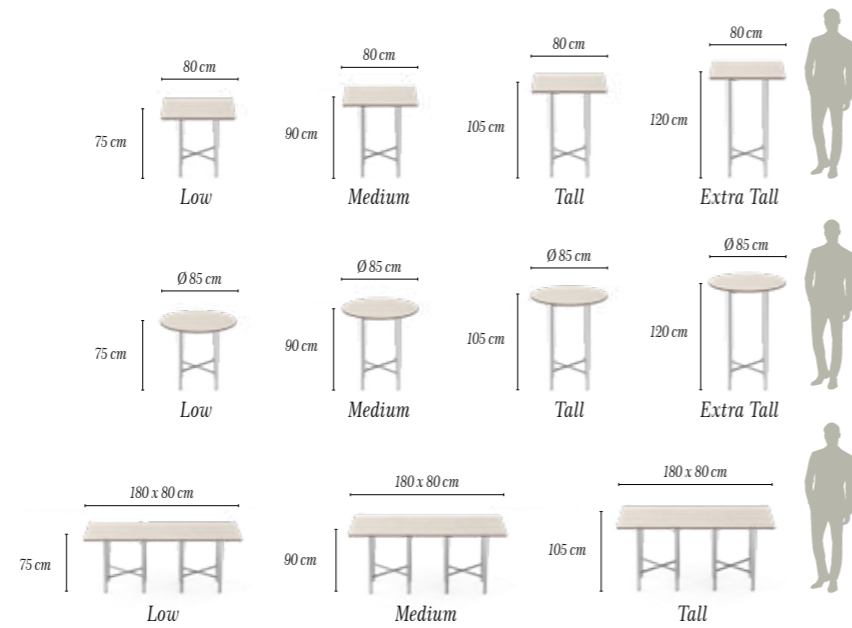

STAINLESS STEEL SATIN FINISH

POWDER COATING BLACK

POWDER COATING GOLD

POWDER COATING COPPER/BRONZE

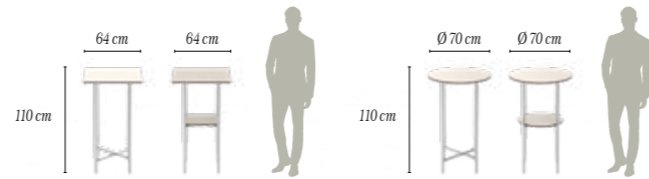

Table Cart

Foldable Cocktail Tables

STRUCTURE FINISHES  HPL FINISHES 

- » Stainless steel 18/10 structure
- » Deep matt or powder coating finishes
- » Compact HPL tops, 10 finishes
- » Magnetic locking system
- » With or without middle shelf
- » Uneven terrain adjustment system
- » Foldable and stored in dedicated cart



STAINLESS STEEL SATIN FINISH

POWDER COATING BLACK

POWDER COATING GOLD

POWDER COATING COPPER/BRONZE



la tavola®

Mixology, Beverage & Vertical Displays

la tavola®



Made in Italy, used to "wow" hotel guests all around the world





Mixology Front Bar

Front Bar & Mixology Front Bar

- » L 181 W 97 H 114 cm
- » Mobile Bar for banqueting, lobby lounge, roof tops, catering and events
- » On heavy duty casters with brakes

- » Available with or without lights
- » Edge Protection System
- » Stainless steel structure, HPL skirting and white marble Okite top

HPL FINISHES



Front Bar

 Dynamic Built-in Modular System available

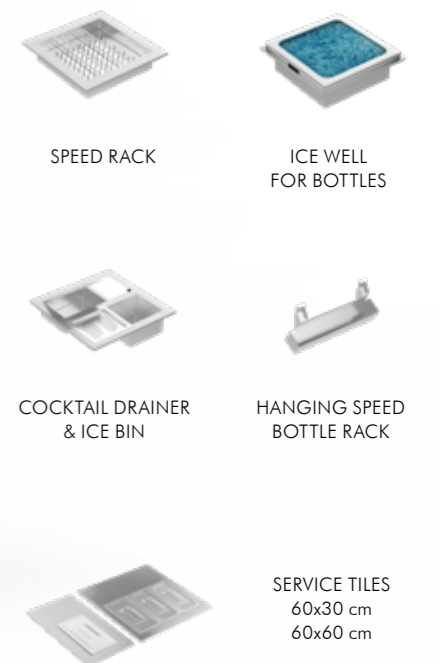



Mixology Cart with Shock Freezer

- | | | |
|-----------------------|--------------------|-----------------------------|
| SMALL | » Shock freezer | » Glass and bottles storage |
| » L 105 W 65 H 110 cm | » Trash bin | » Shelf for storing glasses |
| LARGE | » Storage tools | » Glass countertop |
| » L 135 W 65 H 110 cm | » Cocktail drainer | » Large bottle rack |
| | » Ice holder | » Casters with brakes |

HPL FINISHES

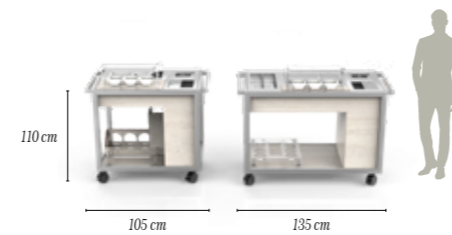



Mixology Cart

SMALL

» L 100 W 60 H 110 cm

LARGE

» L 130 W 60 H 110 cm

- » Trash bin
- » Storage tools
- » Cocktail drainer
- » 2 insulated ice bins
- » Glass and bottle storage

- » Shelf for glass storage
- » Bottle and glass rack
- » Casters with braking system

STRUCTURE FINISHES HPL FINISHES

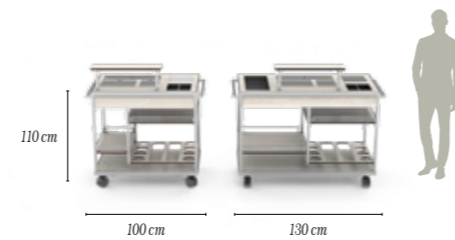

Small Cart

Large Cart

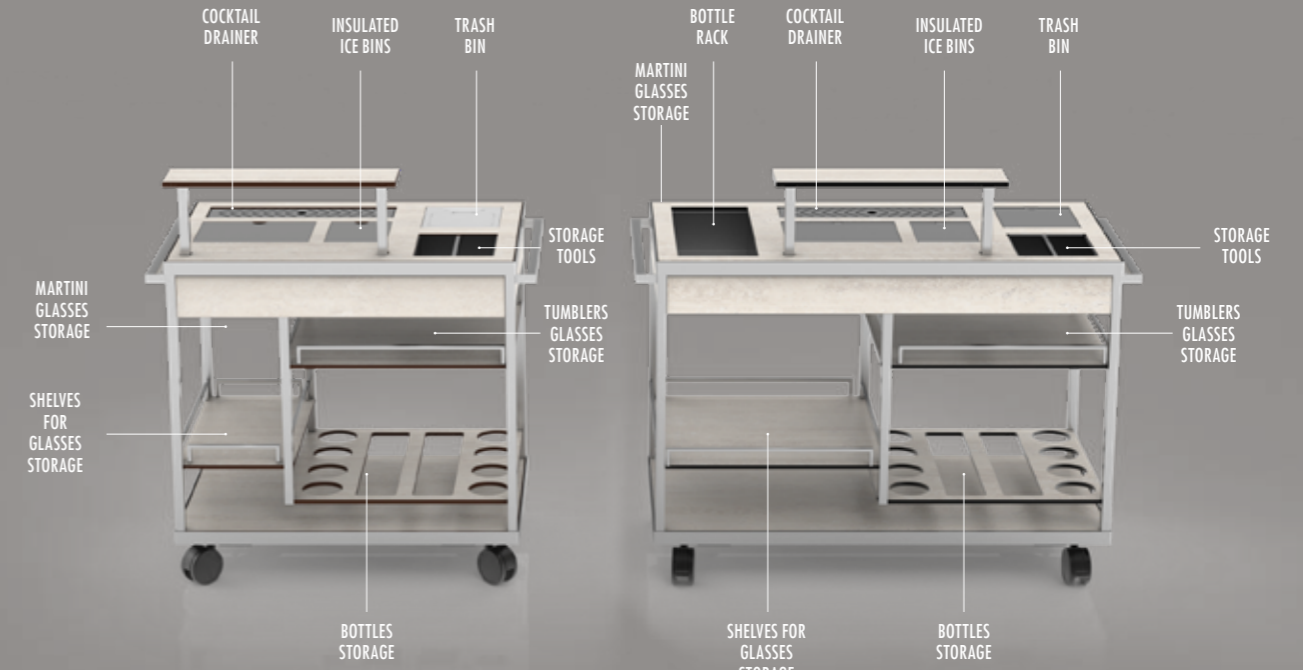

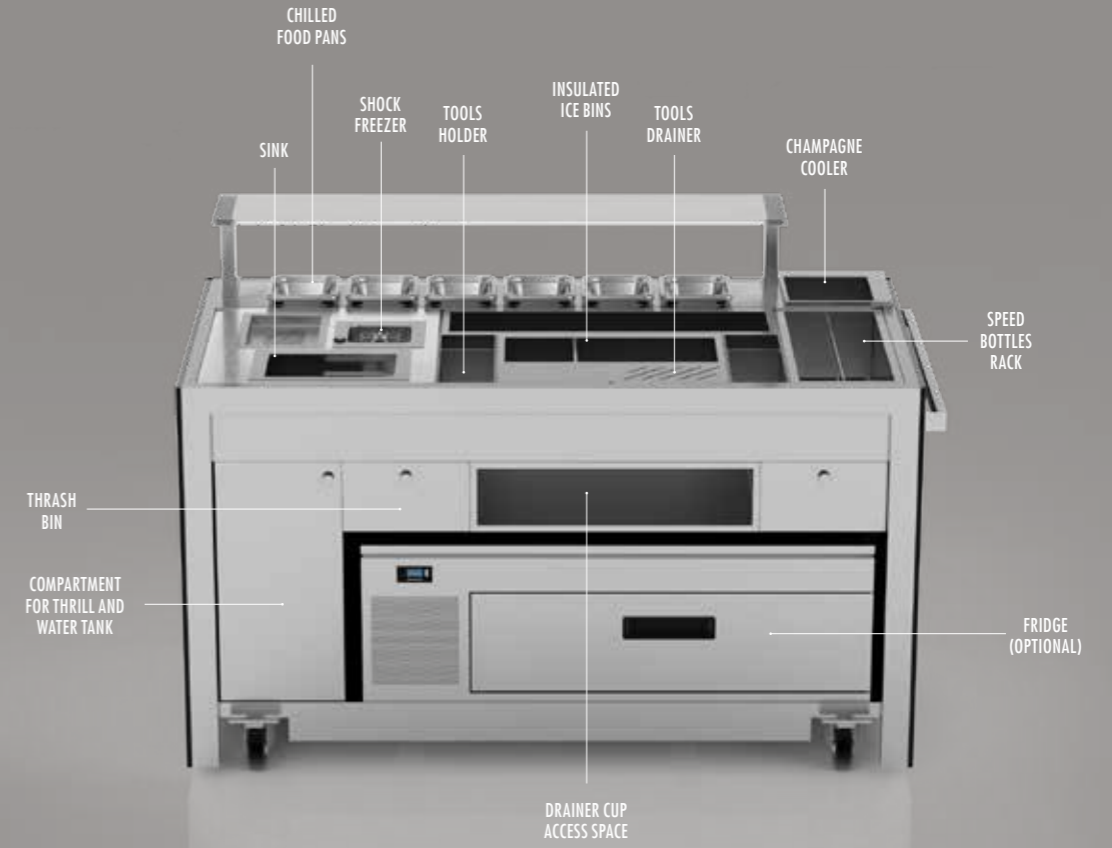

Mixology Rover

- » L 165 W 85 H 110 cm
- » The ultimate tool for professional mixology, with all the add-ons you would expect from a fixed bar
- » Original open plan design for the action to be in plain sight of the customers

FEATURES:

- » Sink
- » Speed bottle rack
- » Glass holder
- » Shock glass freezer
- » 2 insulated ice bins
- » Drainer
- » Tools holder
- » Counter top
- » Tools drainer
- » Champagne cooler
- » Chilled food pans
- » Heavy duty casters with brakes
- » Edge protection system

HPL FINISHES





Beer Cart

STRUCTURE FINISHES ●●●●● HPL FINISHES ●●●●●●●●●●●●●●●●

» L 130 W 60 H 90 cm

» Stainless steel structure, deep matt or powder coated finishes

TOWER one way (one type of beers)

» Cold kit
» With a chrome-plated stainless steel body

CO₂ CYLINDER

» Capacity 4 Kg
» Quick change system

PRE-MIX MACHINE 25 lt.
UNDER COUNTER COOLER
» 220-240V 513W 2A

» Ice bank 10 Kg
» Output per minute 2x 200 cc
» Beverage outlet temperature 3/5°C

KEG

» Quick change system
» Storage area 1 keg 30 lt.

CO₂ PRESSURE REDUCERS
» Relief valve set at 4,8 bar
» Low and low pressure gauge

HEAD KEG (only for standard keg)

» Automatic CO₂ shut off and re-opening

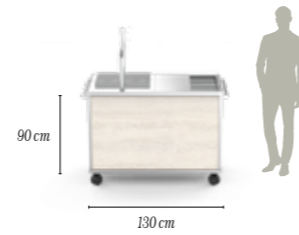

Wine Tasting Cart

STRUCTURE FINISHES ●●●●● HPL FINISHES ●●●●●●●●●●●●●●●●

» L 100 W 60 H 110 cm

» Stainless steel structure, deep matt or powder coated finishes

» Premium bottles display rack

» Optional light and battery for display rack

» Storage for glasses

» Display an safe storage of open bottles

» Concealed compartment for tools

» Concealed compartment for ice or additional storage

» Casters with brakes

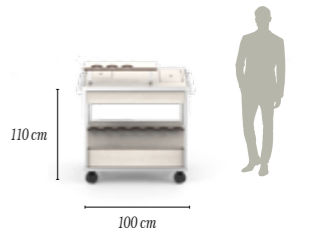



Foldable Back Bar

STRUCTURE FINISHES ●●●●● HPL FINISHES ●●●●●●●●●●●●●●●●●●

- » L 150 W 65 H 170 cm
- » HPL removable shelves
- » Stainless steel foldable structure
- » Minimal storage space
- » Dedicated cart for storage and mobility

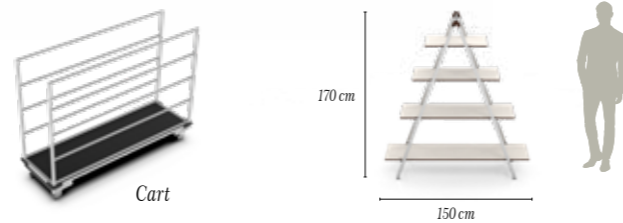

Foldable Back Bar can be easily assembled and disassembled in a few steps and can be moved with its cart



Unfold the structure and place the panels



Foldable Front Bar

HPL FINISHES ●●●●●●●●●●●●●●●●●●

- » L 155 W 62 H 116 cm
- » HPL panels and top
- » Stainless steel foldable structure
- » Minimal storage space
- » Easy handling procedure
- » Dedicated cart for storage and mobility
- » Removable top
- » Compatible with mixology functions

D DYNAMIC BUILT-IN MODULAR SYSTEM®

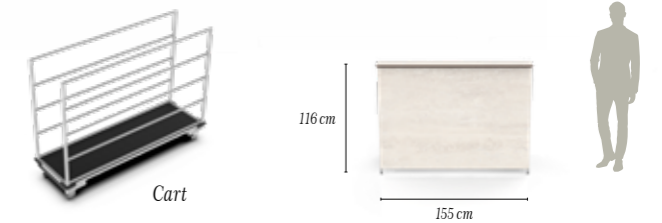

Foldable Front Bar can be easily assembled and disassembled in a few steps and can be moved with its cart

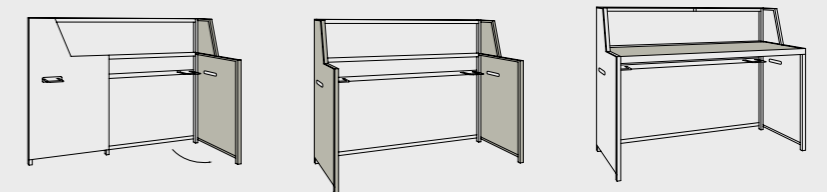

Open the side panels, insert the frame and place the tops



The Tower

STRUCTURE FINISHES HPL FINISHES

- » L 80 W 80 H 170 cm
- » Stainless steel structure
- » Mobile vertical display with 5 large levels

- » Lower edge protection system
- » Casters with brakes
- » HPL panels and base

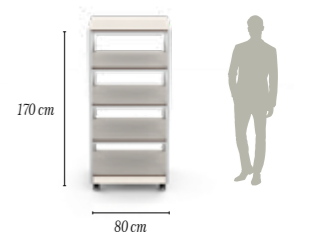



Back Bar

- » L 138 W 65 H 191 cm
- » Removable shelves
- » Hidden heavy-duty wheels with brakes

- » Available with lights
- » HPL panels and matt stainless steel structure

HPL FINISHES

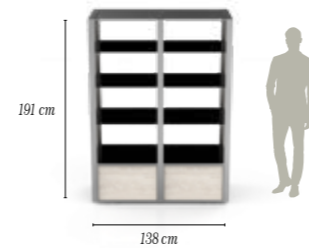

The Octopus

- » L 138 W 70 H 191 FOLDED
- » L 302 W 142 H 191 UNFOLDED
- » Front & back bar all in one

- » Removable shelves
- » Storage space on bottom level
- » Heavy duty designer wheels with brakes

HPL FINISHES

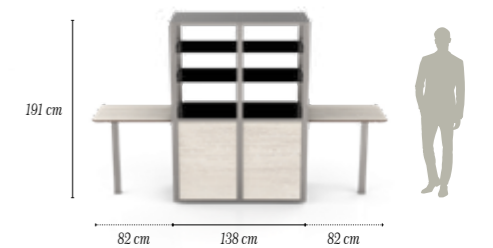



The Egg

HPL FINISHES

- » Ø 110 H 183 cm
- » Mobile vertical display with 4 large levels for food display
- » See-through vertical panels with 360° access
- » Heavy duty stainless steel base
- » Moves on 4 casters
- » Edge protection system
- » Hidden heavy-duty design wheels with brakes

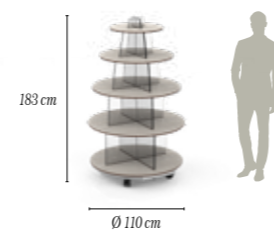

The Tree

HPL FINISHES

- » L 130 W 74 H 183 cm
- » Mobile vertical display with 4 large levels
- » Lower edge protection system
- » Casters with brakes
- » HPL panels available in different colours
- » Also available in a back-lit version for a stunning visual effect during nighttime service

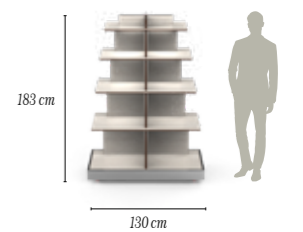

la tavola®

Dedicated Carts and Tables





REMOVABLE BACK DISPLAY BAR



HORIZONTAL SHUTTERS



Coffee Break Cart

HPL FINISHES

- » L 87 W 63 H 90 cm (closed)
- » L 174 W 63 H 90 cm (open)
- » HPL structure
- » Stainless steel 18/10 edge protection system
- » Wheels with braking system
- » Horizontal shutters with heavy duty hinges
- » Large storage areas
- » Removable back display bar

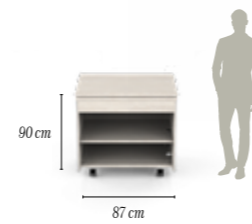



Convivium

SIZES

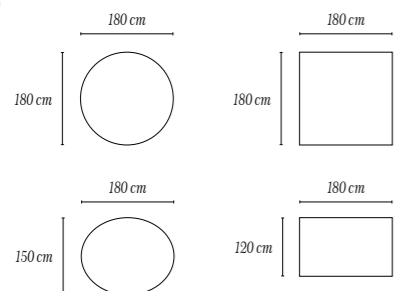

TOP SURFACE FINISHES



LEGS FINISHES



- » High-end linen-less banqueting table
- » Interchangeable in shape over the same set of legs
- » Bearing structure in conglomerated wood covered with HPL
- » Edge banding in highly durable polypropylene
- » Tops are provided in varying dimensions, according to customers' need
- » The 4 legs of each set are made of powder coated INOX 18/10



Carts for tops and legs





Conference Table

TOP SURFACE FINISHES



LEGS FINISHES

- Chromium-plated metal foldable legs
- Black metal foldable legs

- » L 180 W 46 H 75 cm
- » L 180 W 80 H 75 cm
- » Removable Modesty Panel (Optional)
- » Shockproof edges
- » Lightweight

CARTS FOR STORAGE AVAILABLE

- » L 175 W 54 H 106 cm
- » L 175 W 88 H 106 cm



Cart

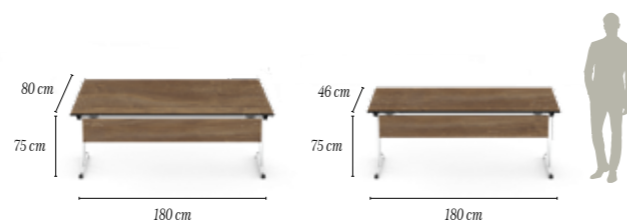



Meeting Table

TOP SURFACE FINISHES



LEGS FINISHES ● Chromium-plated metal foldable legs ● Black metal foldable legs

- » L 180 W 80 H 75 cm
- » L 180 W 80 H 85 cm
- » Removable Skirtings (Optional)
- » Shockproof edges
- » Lightweight

CART FOR STORAGE AVAILABLE

- » L 175 W 88 H 106 cm



Cart



Version with
skirtings



Lectern

HPL FINISHES

- » L 50 W 50 H 130 cm
- » Reading lamp
- » Hidden electric cable system

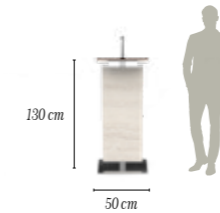

Welcome Desk

HPL FINISHES

- » L 70 W 53 H 115 cm
- » Drawer with amortised closure
- » Internal storage
- » Large work surface
- » Integrated double LED light
- » Heavy duty wheels with brakes
- » Self closing drawers

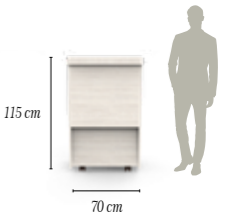

Room Divider

HPL FINISHES

- » L 83 W 12 H 179 cm
- » Heavy duty and durable
- » Styled to match with the existing interior decor and other banqueting furniture
- » Edge protection system
- » Lightweight, portable structure
- » Wooden panels veneered with HPL
Maple / Oak / Walnut / Wenge

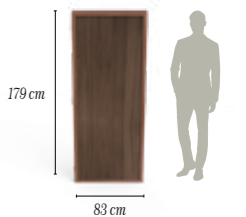



Green Egg Cart







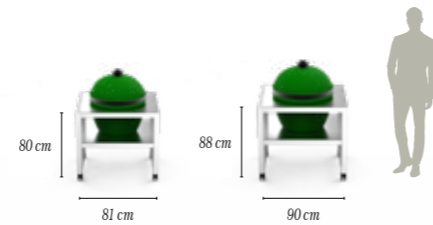



STRUCTURE FINISH 

- » L 81 W 81 H 80 cm | Medium Cart w/o Green Egg
Ø 40 H 78 cm | Green Egg
- » L 90 W 90 H 88 cm | Large Cart w/o Green Egg
Ø 61 H 78 cm | Green Egg

- » Stainless steel satin finish structure
- » New Ice technical tiles
- » Heavy duty wheels with brakes



Mini Fridge Cart

STRUCTURE FINISHES     HPL FINISHES       

- » L 130 W 60 H 90 cm
- » HPL panels available in different colours
- » Heavy duty wheels with brakes

- » Shelves for coffee cups/glasses
- » Fridge unit under top surface

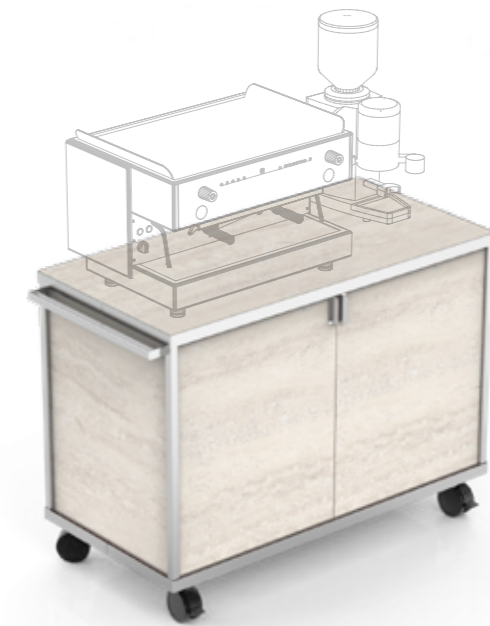
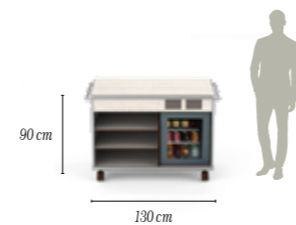

Coffee Cabinet

STRUCTURE FINISHES     HPL FINISHES       

- » L 130 W 60 H 90 cm
- » Heavy duty wheels with brakes

- » HPL panels available in different colours

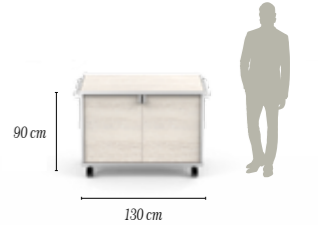

Ouzi Cart

HPL FINISHES       

- » L 125 W 125 H 136 cm
- » Ø 80 (Ouzi function)
- » Removable cover
- » Handle on cover available in different colors
- » Stainless steel food pan 50 cm

- » Power: 700W
- » Heavy duty wheels with brakes
- » HPL panels available in different colours

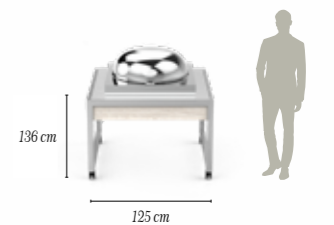

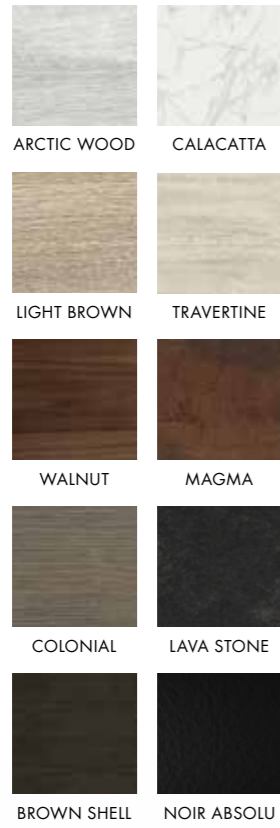

HPL Panels and Tops

LIGHTWEIGHT, DURABLE AND EASY TO CLEAN

The tiles are made of HPL, a high-performing material ideal for the intensive use which is typical in the foodservice industry.

HPL tops and sides are durable and lightweight.

They have a great look and feel, and with a variety of different finishes available, matching your interior décor is easy.

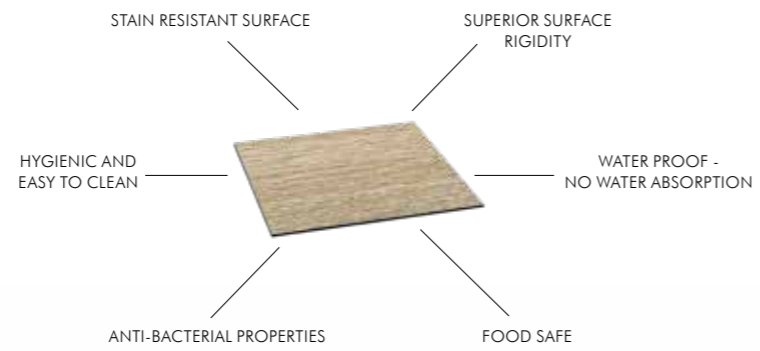

Consulting

Rely on our team of experts to study, design and build your dining areas. Our wide range of products and finishes allows you to create a setting that matches your interior design. If this is not the case, our team of technicians and designers offer you a customization service both in terms of finishes and product design in order to satisfy all your needs and business objectives.

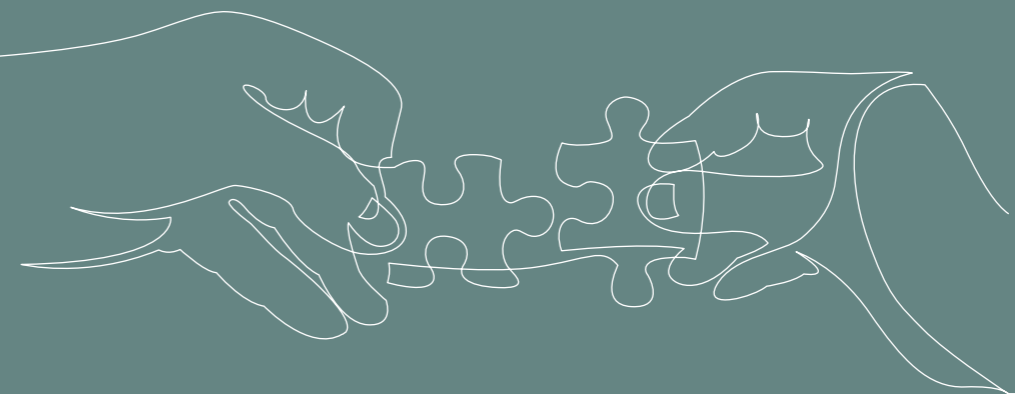



WE DESIGN YOUR BANQUETING AREA STEP BY STEP

Running a banqueting service is not an easy task and we know that one of the key factors that turn a good operation into a best practice, involves the ability to properly manage the incoming flow.

Because of this, we aim to cover this issue for the sake of the ease of movement for both customers and the staff by supporting you in the room's setting.

Our service is intended to help you develop a fully functional and operational banqueting area where all the pre-existing furnishings blend in with a selection of our products carefully chosen to meet your requirements.

Let us forward a proposal based on the location's capacity, be it a hallway stretch, a ballroom or a rooftop terrace, we will provide you with a tailored project that suits your demands.

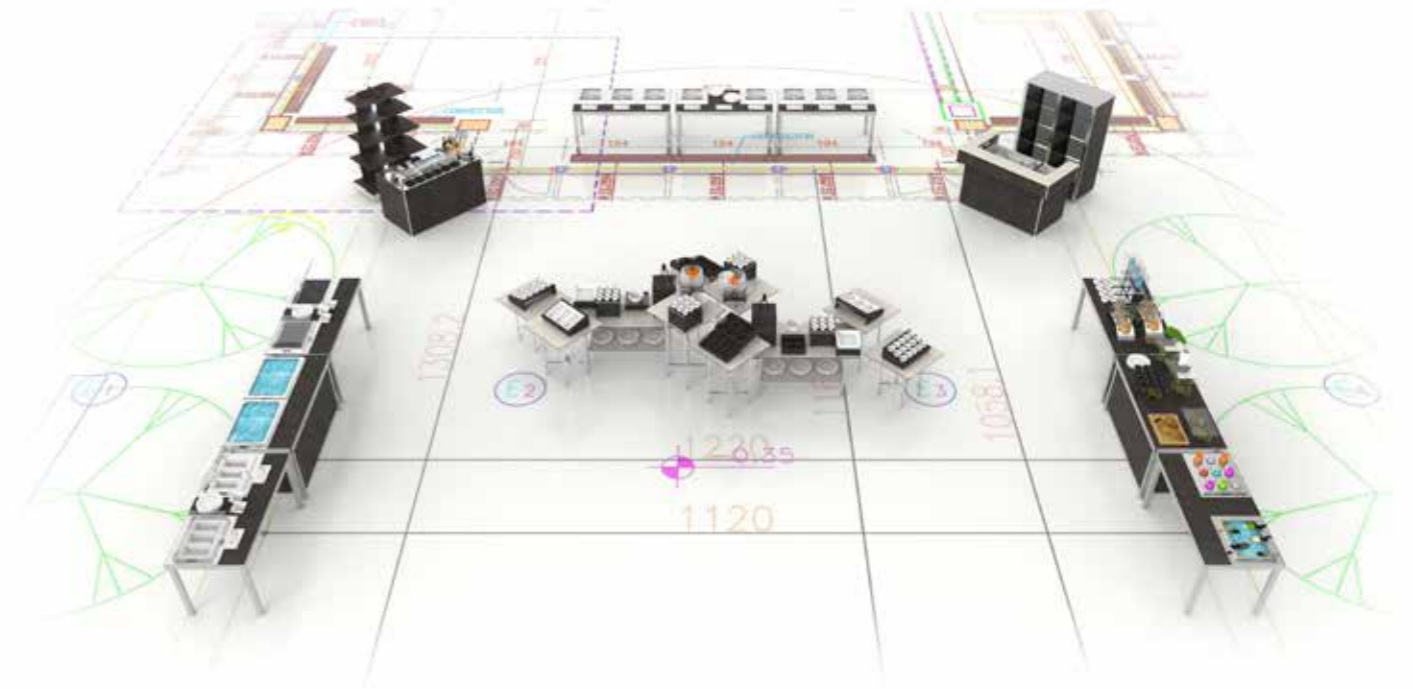

WITH A DEMONSTRATED HISTORY OF STAGING SOME OF THE MOST PRESTIGIOUS HOSPITALITY VENUES AROUND THE GLOBE, YOU CAN RELY ON US WHEN IT COMES TO SEIZING THIS PLACING OUR PRODUCTS.

FILL YOUR ROOM WITH THE SETUP IT DESERVES BLUEPRINT STUDIES & SETUP

THROUGH A CAREFUL STUDY OF YOUR BANQUETING AREA'S LAYOUT, OUR IN-HOUSE TEAM OF ARCHITECTS AND DESIGNERS WILL HELP YOU ASSESSING THE CHOICE AND POSITIONING OF YOUR F&B FURNITURE AND EQUIPMENT. HANDLE YOUR BLUEPRINTS OUT TO OUR EXPERTS AND WATCH AS THEY ARRANGE THE SPACE YOU HAVE AVAILABLE WITHOUT WASTING ITS CAPACITY.

CUSTOMIZATION

TURNING YOUR DESIGN DEMANDS INTO REALITY



Why compromising when you can actually get what you want?

A wide range of selected finishes and materials, combined with a qualified team of in-house designers and engineers, allows a total customization of our products. Should our refined selection not be sufficient to meet your style needs, we can assess your design needs and therefore provide the right fit.

La Tavola's customizations know no limits

The expertise of our team allows us to span across a variety of different solutions and materials. We can customize based on a specific brief, or proactively propose tailor made solutions based on moodboards and broad design directions.



Our growth is a constant defined by the desire to shape adapting to the ever-changing needs of our customers.

The image on the right is an excellent example of customization, wood is the predominant material in this classic and elegant customization that can vary in color and style



The design can be shaped according to your taste and interior decoration

The legs of this table, have a particular design that can be considered classic but with details in the wood carvings that transform it into a design object that does not go unnoticed:



DON'T LIMIT YOUR REQUESTS, OUR TEAM OF EXPERTS CAN MEET ALL YOUR STYLISTIC NEEDS. YOU NAME IT, WE CREATE IT!

DAZZLE YOUR GUESTS

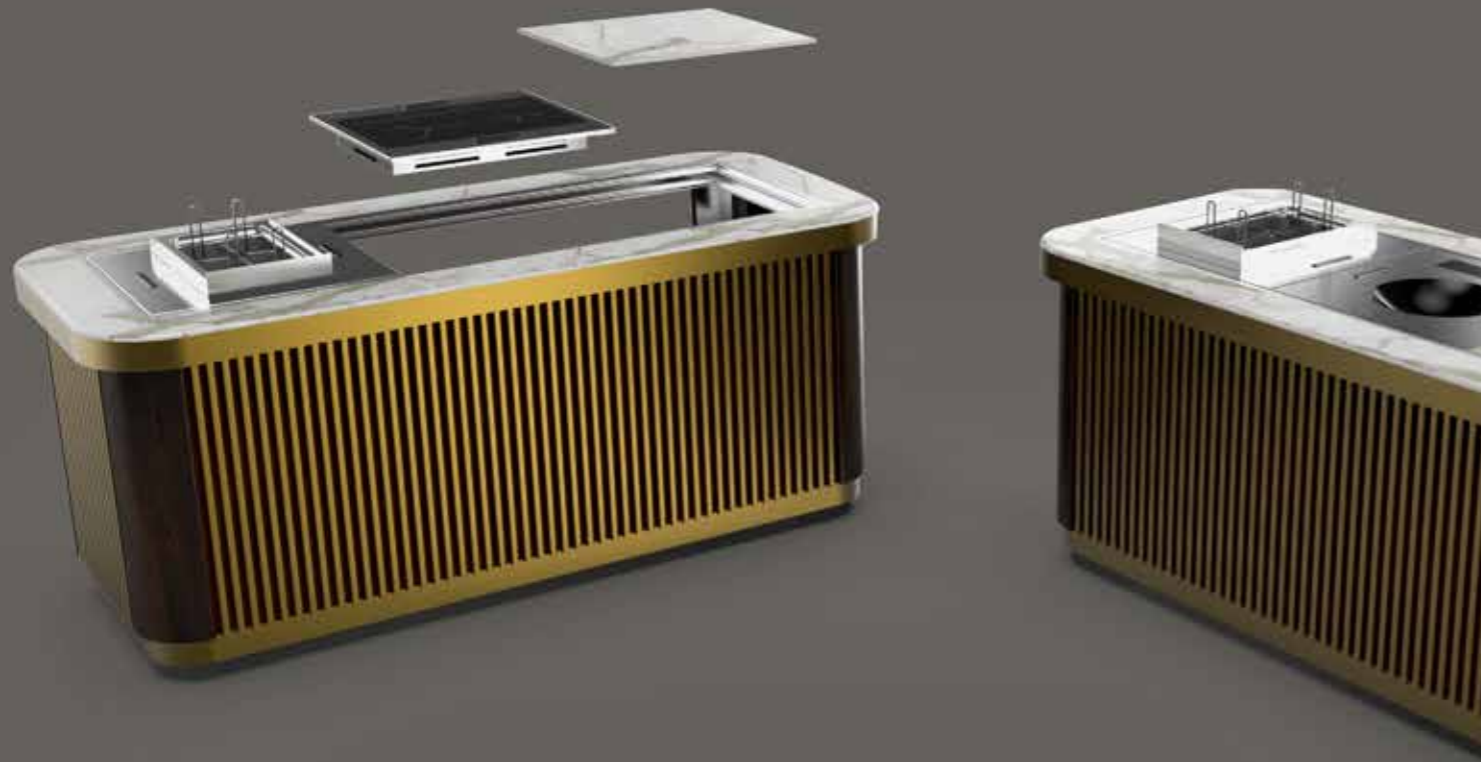

BE PART OF THE NICHE THAT KNOWS
HOW TO PAMPER ITS CUSTOMERS AND
BECOME A HOST TO REMEMBER



A SELECTION OF ELEGANT ITEMS THAT WON'T REMAIN
UNNOTICED, A COLLECTION OF FUNCTIONAL PRODUCTS
THAT PROVE THE WORLD HOW FASCINATING IT IS WHEN
BEAUTY AND DESIGN EFFICIENCY COMBINE.

FULLY
CUSTOMIZABLE
FURNISHINGS
CREATED TO
LEVEL-UP YOUR
CUSTOMER
CARE



EACH SIGNATURE PIECE IS AN EVIDENCE OF ATTENTION TO DETAILS



LUXURY ITEMS

FOOD & BEVERAGE
EQUIPMENT THAT
SEAMLESSLY FITS
WITH ANY LUXURY
CONTEXT.



Luxury Nesting Tables Quartet



Luxury Nesting Tables Trio



Luxury Cocktail Table



Aspiring to redefine the concept of banqueting service means rising personal quality standards to unprecedented heights, hence turning banqueting into an experience for both guests and operators is what triggered us to give life to our Luxury Line.

Pleasure comes in different shapes and with our Luxury Line furnishings and equipment, we aim to train your eyes for beauty seeking.



Luxury Pastry Display

la tavola®

Cocottes, Porcelain and Glassware



Premium quality ceramic



Chalk

Grey

Green

Black



INDIVIDUAL BOWL

black / chalk / grey / green
Ø 16 H 16 cm - LT 0,6



INDIVIDUAL DISH

black / chalk / grey / green
L 20,5 W 14 H 5 cm - LT 0,6



INDIVIDUAL LID/PLATE

black / chalk / grey / green
L 21 W 1,6 H 1,2 cm - LT 1,2



SALAD BOWL

black / chalk / grey / green
Ø 25 H 9,5 cm - LT 2,3



SALAD BOWL

black / chalk / grey / green
Ø 31,5 H 12,5 cm - LT 5



SALAD BOWL

black / chalk / grey / green
Ø 35,5 H 13 cm - LT 7



ROUND DISH

black / chalk / grey / green
Ø 25 H 6,5 cm - LT 1,7



ROUND DISH

black / chalk / grey / green
Ø 31,5 H 6,5 cm - LT 2,6



ROUND DISH

black / chalk / grey / green
Ø 35,5 H 6,5 cm - LT 3,3



SQUARE DISH

black / chalk / grey / green
L 30 W 30 H 6,5 cm - LT 3,1



LARGE SQUARE DISH

black / chalk / grey / green
L 42 W 42 H 6,5 cm - LT 6,5



LONG DISH

black / chalk / grey / green
L 41,5 W 15 H 6,5 cm - LT 2



LONG TRAY

black / chalk / grey / green
L 42 W 15 H 1,7 cm - LT 0,6



SAUCE POT

black / chalk / grey / green
Ø 14,5 H 17 cm - LT 1,2

Premium quality ceramic



White

Cherry

Black

Green

Grey

Chalk



FOOD PAN 1/1 GN

white / cherry / black / chalk / grey / green
L 53 W 32,5 H 6,5 cm - LT 5



FOOD PAN 1/2 GN

white / cherry / black / chalk / grey / green
L 32,5 W 26,5 H 6,5 cm - LT 2,3



FOOD PAN 2/3 GN

white / cherry / black
L 34,5 W 26,5 H 6,5 cm - LT 2,3



FOOD PAN 1/3 GN

white / cherry / black / chalk / grey / green
L 32,5 W 17,5 H 6,5 cm - LT 1,8



FOOD PAN 2/4 GN

white / cherry / black
L 53 W 16 H 6,5 cm - LT 2



FOOD PAN 1/4 GN

white / cherry / black
L 26,5 W 16 H 6,5 cm - LT 0,85



BOWL

white / cherry / black
Ø 24 H 9 cm - LT 2



JAPANESE BOWL

white / cherry / black
Ø 11 H 6,5 cm - LT 0,2



UTENSIL HOLDER

white
Ø 13 H 15 cm - LT 1,3

Sleek lines,
reinforced edges,
perfectly stackable
and easy to handle



No color-fading,
no scratches,
food safe

Rapid, even heat diffusion

Chip resistant

Premium quality ceramic cocottes



White Black Silver Copper Gold Platinum Glass



COCOTTE WITH COVER

white / black / silver / copper / gold / platinum / glass
 Ø 26 H 14,5 cm

COCOTTE WITH COVER

white / black / silver / copper / gold / platinum / glass
 Ø 28 H 13,5 cm

OVAL COCOTTE WITH COVER

white / black / silver / copper / gold / platinum / glass
 L 32,5 W 26 H 16 cm

TAJINE WITH COVER

silver / copper / matt slate
 Ø 32 H 21,5 cm



CERAMIC RECTANGULAR PAN

white
 L 30,5 W 21,5 H 7 cm



DOUBLE BOILER INSERT FOR COCOTTE

white
 Ø 26 H 6,5 cm



SUPPORT FOR COVER

stainless steel
 L 12 W 6 H 8 cm

Cast iron cocottes



Black Graphite Grey Cherry White Cherry



ROUND WITH COVER

black / graphite grey
 Ø 10 H 7 cm - 0,25



ROUND WITH COVER

black / graphite grey / cherry
 Ø 18 H 14,5 cm - LT 1,70



ROUND WITH COVER

black / graphite grey / cherry
 Ø 20 H 14,5 cm - LT 2,20



ROUND WITH COVER

black / graphite grey / cherry
 Ø 22 H 14,5 cm - LT 2,60



ROUND WITH COVER

black / graphite grey / cherry
 Ø 26 H 14,5 cm - LT 4,60



ROUND WITH COVER

black / graphite grey / cherry
 Ø 30 H 18 cm - LT 7,65



OVAL WITH COVER

black
 L 41 W 32,5 H 19 cm - LT 12



TAJINE

white / cherry
 Ø 28 H 21 cm - LT 2

VERSATILE AND PRACTICAL:
 Compatible with any heating source including induction, stovetop, electrical unit



SAFE AND FOOD FRIENDLY:
 Is made of natural mineral materials. Free of chemicals and heavy metals

DURABLE AND RESISTANT:
 Revolutionary light-weighted and resistant at the same time

EASY CARE:
 dishwasher safe, naturally non-stick

Nickel steel knob



Unique, interior matte texture results in exceptional browning

Smooth enamel bottom works on all stovetops, including gas, electric, glass, ceramic, induction, and halogen

Heavy weight, tight-fitting lid retains moisture

Porcelain items



SQUARE DIAMOND PLATE

L 31 W 31 H 2,2 cm
L 26 W 26 H 2 cm
L 21 W 21 H 1,6 cm
L 15 W 15 H 1,6 cm



OBLONG DIAMOND PLATE

L 15 W 38 H 1,5 cm
L 15 W 30 H 1,5 cm



SQUARE MEAT PLATE

L 30,3 W 30,3 H 4,5 cm
L 25,2 W 25,2 H 4,5 cm
L 20 W 20 H 2,9 cm
L 13,5 W 13,5 H 2,5 cm



OBLONG MEAT PLATE

L 39,8 W 29,8 H 3 cm
L 35,2 W 25,8 H 4,7 cm
L 30 W 20 H 5 cm



SQUARE MEAT PLATE, ASH

L 31 W 31 H 3,5 cm
L 17,8 W 17,8 H 2,2 cm



ROUND MEAT PLATE, ASH

Ø 31 H 3,8 cm
Ø 15 H 2 cm



LOTUS BOWLS

L 21 W 15 H 11,5 cm (white)
L 18 W 12 H 9,5 cm (white or black)
L 16 W 9 H 7,5 cm (white or black)



AMAZING SQUARE BOWL

L 20,5 W 20,5 H 3,5 cm



TRIANGLE FIGURE PLATES

L 30,2 W 11,8 H 2 cm
L 28 W 14,3 H 3 cm



OBLONG DEEP PLATES

L 30,5 W 9,5 H 4,5 cm
L 25,5 W 7,8 H 4 cm



SALAD BOWLS

Ø 16 H 5,7 cm
Ø 12 H 5,5 cm
Ø 12 H 3,8 cm



SQUARE FIGURE BOWLS

White or Black
L 23 W 23 H 9,5 cm
L 20 W 20 H 8,5 cm
L 15 W 15 H 7,5 cm
L 12 W 12 H 6 cm



ONDA PLATES

L 30,5 W 25 H 3,5 cm
L 25,3 W 21 H 3 cm



TAPAS TRAYS

L 30 W 13 H 2,5 cm



TAPAS PLATES

L 35,6 W 10 H 2 cm



DASH BOWLS WITH FOOT

Ø 11,5 H 5 cm
Ø 11,5 H 5 cm

Porcelain items



GOHAN CUPS

Ø 11 H 5 cm (white or black)
Ø 9,5 H 4 cm (white)



ASH CYLINDRICAL CUP

Ø 5,5 H 6 cm



SAUCE TRAY, 2 COMPARTMENTS

L 14,5 W 6,5 H 1,8 cm



RELISH PLATE

25,5 (x3) H 3 cm



WASABI TRAYS

L 39 W 4,5 H 2,5 cm
L 35 W 4,5 H 2,5 cm



SAUCE BOWL

L 13 W 11 H 5,5 cm



OBLONG FINGER FOOD BOWL, 2 COMPARTMENTS

L 16 W 6,5 H 4 cm



SQUARE FINGER FOOD BOWL, 4 COMPARTMENTS

L 15 W 15 H 2,4 cm



MISE EN BOUCHE

L 5,3 W 10,7 H 2,8 cm



ROUND BOWL

Ø 15 H 8 cm



CONICAL BOWL

Ø 15 H 8 cm



HALF PLATE

L 20 W 10 H 2 cm



DEEP SQUARE BOWL

L 14,1 W 14,1 H 5,5 cm



BREAKFAST ITEMS

MUG W/O SAUCER

cl 30 Ø 12 H 11 cm



HIGH CUP W/ OBLONG SAUCER

cl 24 H 9,5 cm



STACKABLE ESPRESSO COFFEE CUP W/ SAUCER

cl 10 H 6,4 cm



STACKABLE ESPRESSO COFFEE CUP

cl 10 H 6,4 cm



SAUCER FOR STACKABLE ESPRESSO COFFEE CUP

cm 12,2

STACKABLE TEA CUP W/ SAUCER

cl 21 H 8,1 cm

STACKABLE TEA CUP W/ SAUCER

cl 21 H 8,1 cm

STACKABLE BREAKFAST CUP W/ SAUCER

cl 28 H 9 cm

STACKABLE BREAKFAST CUP

cl 28 H 9 cm

SAUCER FOR STACKABLE BREAKFAST CUP

cm 16,6

Decorative glassware

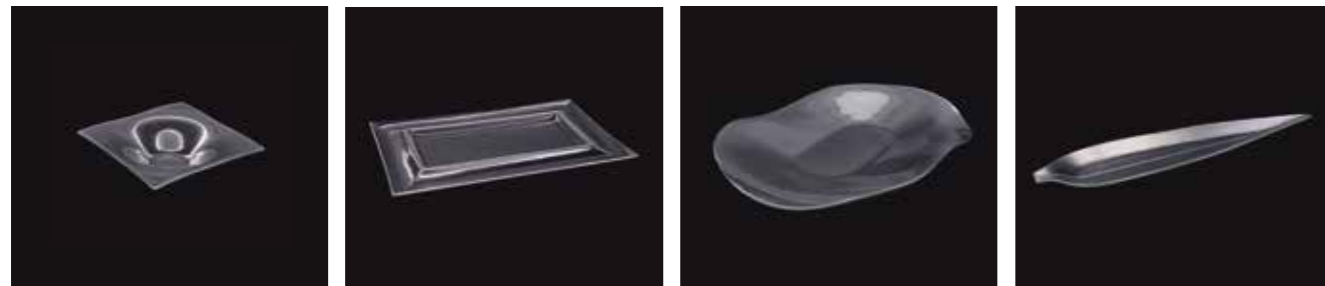

TAV1908 - 25 x 25 cm

TAV1927 - 25 x 40 cm

TAV1802 - 32 x 41 cm

TAV1816 - 14 x 55 cm

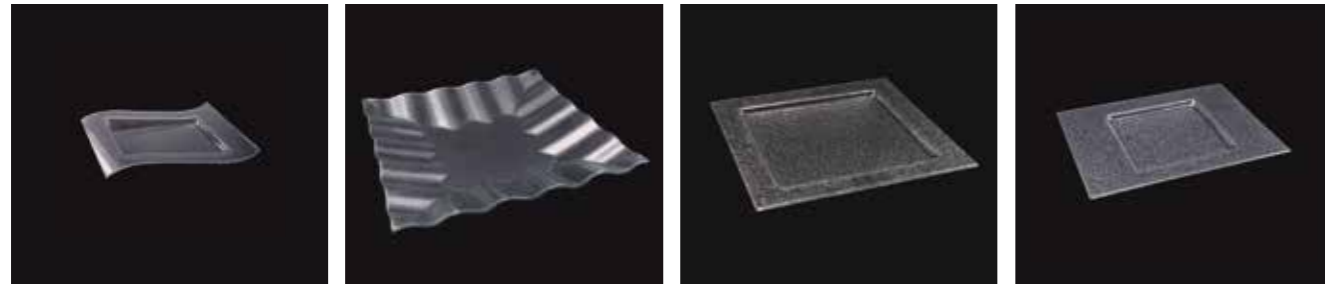

TAV1722 - 24 x 31 cm

TAV1756 - 42 x 42 cm

TAV1001 - 40 x 40 cm

TAV1041 - 28 x 36 cm

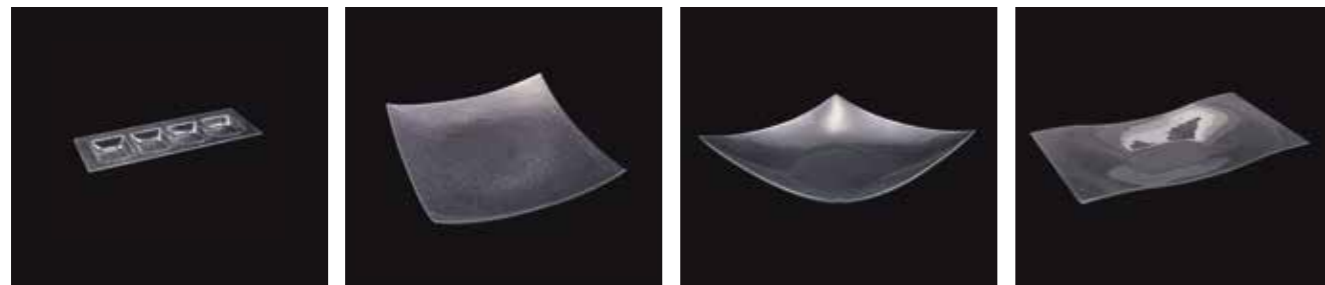

TAV4034 - 15 x 30 cm

TAV1002 - 30 x 30 cm

TAV1005 - 30 x 40 cm

TAV1718 - 20 x 42 cm

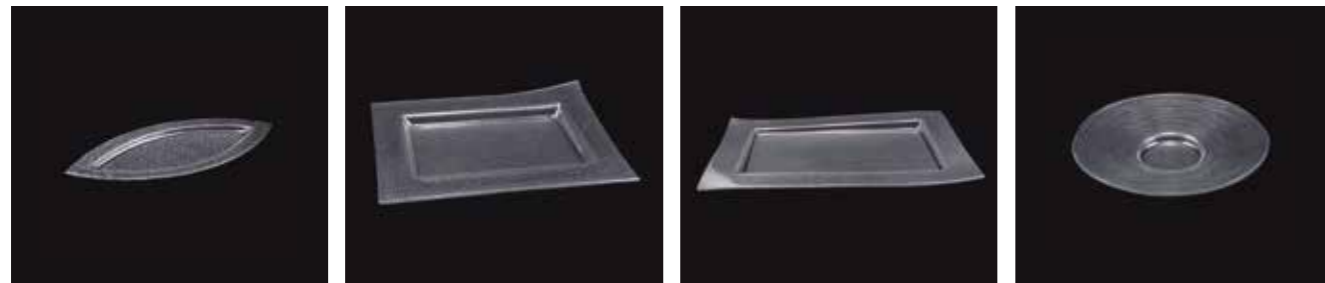

TAV1009 - 23 x 36 cm

TAV1180 - 25 x 40 cm

TAV1006 - 32 x 53 cm

TAV1319 - Ø 31 cm

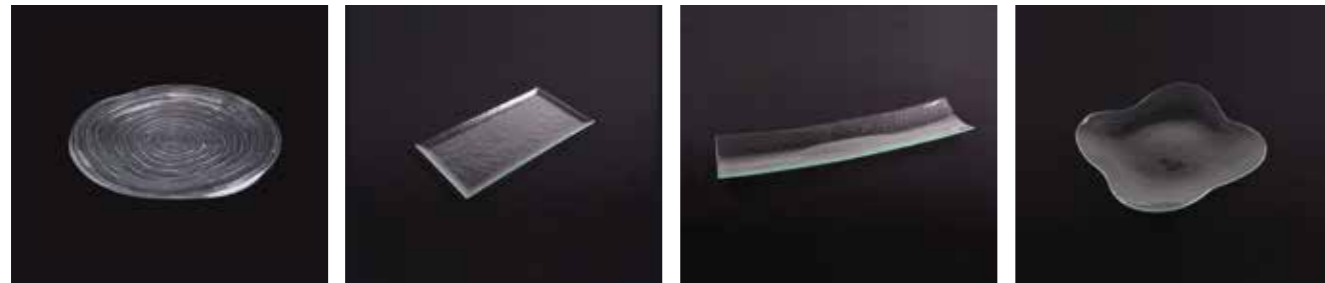

TAV1185 - Ø 32 cm

TAV1870 - 13 x 45 cm - standard clear
TAV1873 - 30 x 30 cm - smoked

TAV1243 - 15 x 46 cm

TAV1754 - 30 x 30 cm

Decorative glassware



8 x 8 cm
TAV171708SC - standard clear
TAV171708SM - smoked

10 x 10 cm
TAV172710SC - standard clear
TAV172710SM - smoked

7,5 x 7,5 cm
TAV100107SC - standard clear
AV100107SM - smoked

10 x 10 cm
TAV102110SC - standard clear
TAV102110SM - smoked

8 x 8 cm
TAV187708SC - standard clear
TAV187708SM - smoked

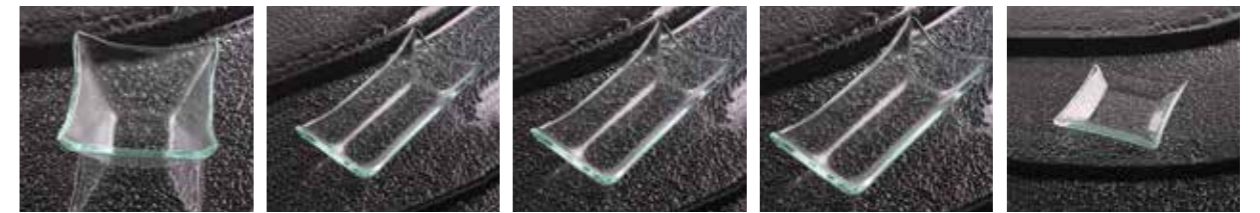

9 x 9 cm
TAV187709SC - standard clear
TAV187709SM - smoked

6 x 12 cm
TAV187912SC - standard clear
TAV187912SM - smoked

7 x 13 cm
TAV187913SC - standard clear
TAV187913SM - smoked

8 x 14 cm
TAV187914SC - standard clear
TAV187914SM - smoked

8 x 8 cm
TAV100308SC - standard clear
TAV100308SM - smoked



9 x 9 cm
TAV100309SC - standard clear
TAV100309SM - smoked

6 x 11 cm
TAV100411SC - standard clear
TAV100411SM - smoked

6 x 12 cm
TAV100412SC - standard clear
TAV100412SM - smoked

8 x 8 cm
TAV186708SC - standard clear
TAV186708SM - smoked



Patents and Proprietary Designs

**All product designs are registered by La Tavola.
Any reproduction or imitation is forbidden by law.**

The following products are covered by international patents: Dynamic Built-in Modular System®, Catering Table®, Magic Chafer®, Multi-purpose Tops®, Cover Oven Dry Chafer®, Dry Warmer for Induction® and Dry Chafer for Induction®.

LA TAVOLA will not hesitate to take legal action against any infringement of patents or registered designs in order to fully protect its intellectual property.

The purchasing of imitation goods may also have legal implications. Design and technical information shown in this document is subject to copyright and may not be used by other parties without prior written approval from LA TAVOLA.

WARRANTIES

All LA TAVOLA products are guaranteed against any defect of manufacture or material. If, after the manufacturer's inspection, they are found to be defective, they will be repaired or replaced free of charge.

Electrical items and induction-powered items have a 1-year warranty period. After 1-year, La Tavola will ensure limitless availability of spare parts needed as well as consulting and service for repairs.

The warranty does not include damages resulting from misuse, abuse, wear tear or incorrect maintenance.

CARE AND MAINTENANCE

(Sorted by by product category/material)

Freestanding buffetware, Action Stations and banqueting furniture

- » Stainless steel parts: Wash the items with hot water and neutral detergents on a soft cloth (do not use detergent containing chlorine and/or alkaline cleaners). Dry the items thoroughly and store them in a dry place. Never use any type of scraper or steel wool which will scratch the surface of the items. The items must be washed as soon as possible after use to avoid any prolonged contact with food remnants. Do not wash in the dishwasher.
- » PETG elements (transparent covers): Wash the items with water and neutral detergents on a soft cloth (do not use detergent containing chlorine and/or alkaline cleaners). Never use any type of scraper or steel wool which will scratch the surface of the items. Do not wash in the dishwasher.
- » High Pressure Laminates (HPL): wash HPL items with water and neutral detergents on a soft cloth. Never use any type of scraper or steel wool which will scratch the surface of the items. Do not wash in the dishwasher.
- » Organic & Mineral Risers: Ecoresin, like all thermoplastic resin materials, should be cleaned periodically a regular, seasonal cleaning program will dramatically help prevent noticeable weathering and dirt build up. Rinse the sheets with lukewarm water (be careful not to expose edges of organic or fabric interlayers to water) remove dust and dirt from the risers with a soft cloth or sponge and a solution of mild soap and/or liquid detergent in water. Rinse thoroughly with lukewarm water. Never use scrapers or squeegees. Keep edges dry and free of liquids. Do not rub with a dry cloth. Because the materials used are organic in nature (i.e. leaves, branches and twigs) it is natural for them to alter slightly in appearance over time. Natural materials are also subject to inherent inconsistency in color, texture and shape. Slight delamination on saw cut edges is also to be expected.

Flatware

- » Stainless steel: Wash the items in hot water and neutral washing detergent after each use. Do not use detergents containing chlorine and/or alkali cleaners, then dry thoroughly the items and store them in a dry room. Never use any type of scraper or steel wool which will scratch the surface of the items. Any food remains should be thoroughly cleaned up. The items must be washed as soon as possible after use. When washing in a dishwasher of make sure that at the end of the cycle the items come out perfectly dry otherwise wipe them thoroughly by hand. The above recommendations are particularly meant for the care of the blades, which are made of Aisi 420 stainless steel. This type of stainless steel is the most suitable to ensure a long-lasting cutting edge to the blades, but it is less resistant to the corrosion than the 18-10 (Aisi 304) stainless steel type, which is used to manufacture the forks, the spoons and the handles of the hollow handle knives.
- » Silver-plated: The same maintenance instructions of the stainless-steel ware apply. The silver coating can oxidize due to the contact with certain types of food and in very humid climates. This process is not a defect and it is not a sign of damage, but it is a natural characteristic which only alters the color of the surface, initially to yellowish and eventually to brown. Oxidation can be quickly removed with a common silver polishing product, either in form of paste or of liquid solution. In the latter case, it must be taken the precaution of avoiding a prolonged contact of the solution with the stainless-steel blades as they could be affected by corrosion. The items must be removed from the dishwasher as soon as the cycle is completed and wiped dry with a soft cloth, even if they seem dry. The period of time that the items are exposed to hot steam and the hydrochloric acidity created within the dishwasher, therefore items should be removed as soon as possible from the dishwasher after the end of the washing cycle.
- » PVD and Titanium Coated: In case of appearance of dark spots (caused by organic substances and/or calcium deposits due to an inadequate washing /drying cycle), remove them by simply wiping off the surfaces with a soft cloth soaked with lemon soap or vinegar. If the lemon soap or the vinegar are not sufficient to remove particularly resistant spots, then (and only in that case) use a soft cloth soaked with a liquid metal polisher. We recommend using "Sidol" by Henkel, but most probably any kind of liquid metal polisher is as good as "Sidol". Avoid polishing the surfaces with abrasive cloth or metal polishing paste. Never use scrubbing sponges. PVD coated flatware does not tarnish, and does not require any special maintenance otherwise. In order to delay as much as possible the incurrence of visible wear and tear, handle with as much care as possible during the washing cycle. Wash and store the knives separately from the forks and the spoon.

Copyright © LA TAVOLA srl

All rights reserved.

Text and images are property of La Tavola srl and any reproduction (even partial) of the catalogue is forbidden.

In the constant search for technical and functional improvements, La Tavola srl reserves the right to make changes to its products without notice.

Graphic design
D-Lab - www.laboratoriodesign.it

Photography
Dario Canova
Livio Bourbon

Rendering
La Tavola Engineering Dpt.

JUN 2021

la tavola

LA TAVOLA S.r.l. - Via Pietro Micca, 51 - 13100 Vercelli - Italy
phone +39 0161.251959 - contact@la-tavola.it
www.la-tavola.it